

User's Manual

Models UT150, UT152, UT155 Temperature Controller



Please read through this user's manual to ensure correct usage of the controller and keep it handy for quick reference.

Contents

1. Notice	1
2. What is on the Front Panel?	1
3. Installing the Controller	1
4. Panel Cutout Dimensions and External Dimensions	1
5. Wiring	2
6. Hardware Specifications	2
7. Key Operations	3
8. Troubleshooting	3

Revision Record

IM 05C01E12-01E 1st Edition: Oct. '00
2nd Edition: Feb. '01
3rd Edition: Jun. '04

YOKOGAWA
Yokogawa Electric Corporation

IM 05C01E12-01E
Jun. 2004 3rd Edition

1. Notice

The following safety symbol is used both on the product and in this user's manual.



This symbol stands for "Handle with Care." When displayed on the product, the operator should refer to the corresponding explanation given in the user's manual in order to avoid injury or death of personnel and/or damage to the product. In the manual the symbol is accompanied by an explanation of the special care that is required to avoid shock or other dangers that may result in injury or loss of life.

The following symbols are used in this manual only.



NOTE

Indicates that operating the hardware or software in a particular manner may lead to damage or result in system failure.



IMPORTANT

Draws attention to information that is essential for understanding the operation and/or features of the product.

■ Exemption from Responsibility

Make sure that all of the precautions are strictly adhered to. Yokogawa Electric Corporation assumes no liability for any damage resulting from use of the instrument in contradiction to the precautions.

Also, Yokogawa Electric Corporation assumes no liability to any party for any loss or damage, direct or indirect, caused by the use or any unpredictable defect of the instrument.

2. What is on the Front Panel ?

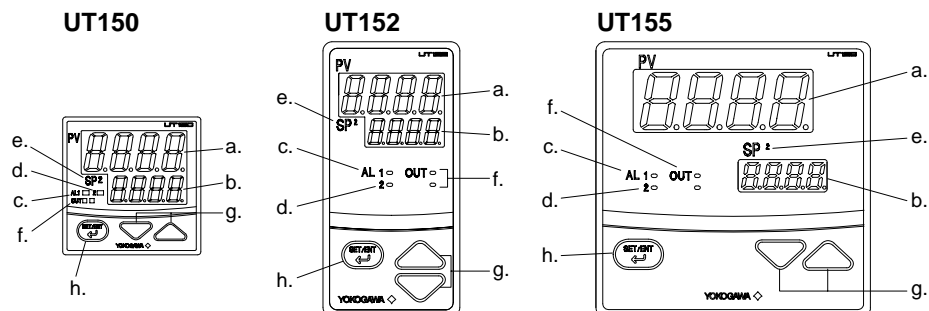

Name	Function
a. PV display (red)	Indicates PV (measured value) and character information such as parameter codes and error codes.
b. SP display (green)	Indicates SP (target setpoint) and parameter values.
c. Alarm 1 (AL1) lamp (red)	Lit when alarm 1 is activated.
d. Alarm 2 (AL2) lamp (red)	Lit when alarm 2 is activated.
e. SP2 lamp (green)	Lit when SP2 is being used for control operation.
f. Output (OUT) display lamps UT150: (Left: orange; right: green) UT152, UT155: (Upper: orange; lower: green)	Lit while control output is being output. • The left (upper) lamp is lit in orange during control output of standard type. • In heating/cooling control, the left (upper) lamp lights up in orange when the heating-side output is active; while the right (lower) lamp lights up in green when the cooling-side output is active.
g. Data change keys (Indicated as simply the and keys hereafter.)	• Changes SP and the parameter values. • Pressing the key decreases the data value and pressing the key increases it. Holding down the key will gradually increase the speed of the change.
h. SET/ENT key (data registering key) (Indicated as simply the key hereafter.)	• Registers the data value changed using the data change keys. • Switches between operating display or parameter setting displays sequentially. • Pressing the key for 3 seconds or longer in the operating display retrieves the operating parameter setting display. • Pressing the key for 3 seconds or longer in either an operating or setup parameter setting display transfers back to operating display 1. (See page 3.)

3. Installing the Controller

CAUTION

To prevent electric shock, the source of power to the controller must be turned off when mounting the controller on to a panel.

NOTE

To install the controller, select a location where:

- No-one may accidentally touch the terminals;
- Mechanical vibrations are minimal;
- Corrosive gas is minimal;
- The temperature can be maintained at about 23°C with minimal fluctuation;
- There is no direct heat radiation;
- There are no resulting magnetic disturbances;
- The terminal board (reference junction compensation element, etc.) is protected from wind;
- There is no splashing of water; and
- There are no flammable materials.

Never place the controller directly on flammable items.

If the controller has to be installed close to flammable items or equipment, be sure to enclose the controller in shielding panels positioned at least 150mm away from each side. These panels should be made of either 1.43mm thick metal-plated steel plates or 1.6mm thick uncoated steel plates.

- Mount the controller at an angle within 30° from horizontal with the screen facing upward. Do not mount it facing downward.

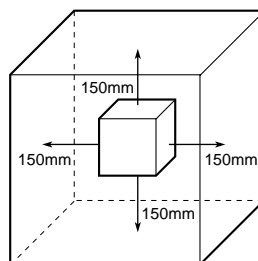
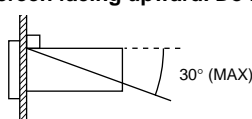

■ Checking Package Contents

Before using the product, check that its model & suffix codes are as you ordered.

Model and Suffix Codes

Model	Suffix code	Description
UT150 UT152 UT155		Temperature controller
Control output for standard-type (or for heating)	-R -V -A	Relay output (time-proportional PID or on/off control) Voltage pulse output (time-proportional PID) 4 to 20mA output (continuous PID)
Control output for cooling	N R V A	No cooling output (standard type) Relay output (time-proportional PID or on/off control) Voltage pulse output (time-proportional PID) 4 to 20mA output (continuous PID)
Option	/AL /HBA /EX /RET /RS /N24	Alarm outputs (2 points) Heater disconnection alarm (includes optional /AL function) SP1/SP2 switching, starting of timer, and RUN/STOP switching by external contacts PV retransmission output in 4 to 20mA Communication function Power Supply 24V DC / 24V AC

Note: When specifying the /RS option, be sure to order the required number of copies of Communication Functions User's Manual separately.

Check the package contents against the list below.

- Temperature controller 1
- Mounting bracket 1 for UT150
2 for UT152, UT155
- User's manual (this manual) 1

Yokogawa Electric Corporation

Network Solutions Business Division
2-9-32, Naka-cho Musashino-shi, Tokyo 180-8750 Japan
Phone: +81-422-52-7179 Facsimile: +81-422-52-6793

4. Panel Cutout Dimensions and External Dimensions

1. General Mounting

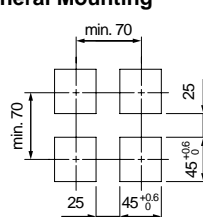

UT150

Unit: mm

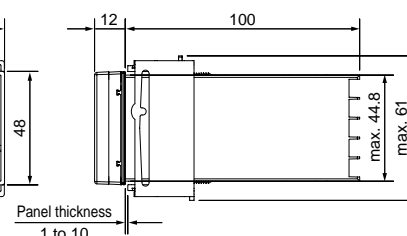
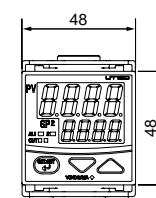
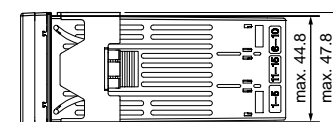

2. Side-by-side Close Mounting

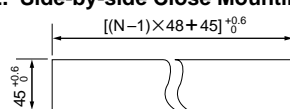

N is the number of controllers.
If N ≥ 5, then measure the actual length.

1. General Mounting

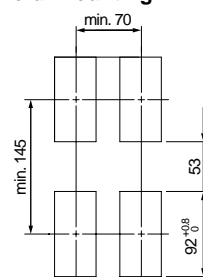

UT152

Unit: mm

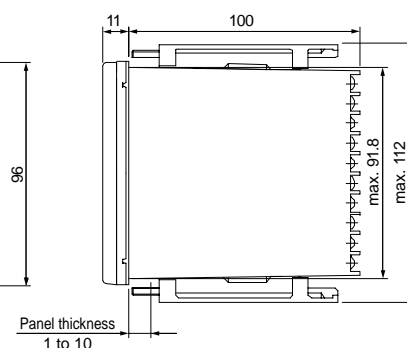
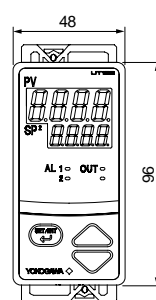
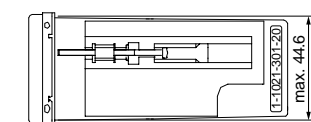

2. Side-by-side Close Mounting

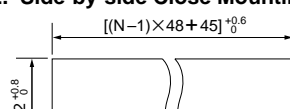

N is the number of controllers.
If N ≥ 5, then measure the actual length.

1. General Mounting

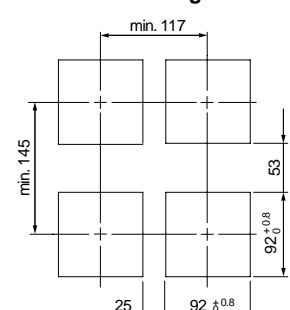

UT155

Unit: mm

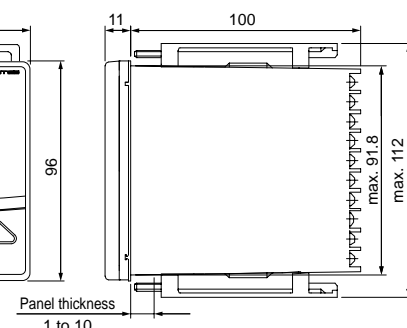
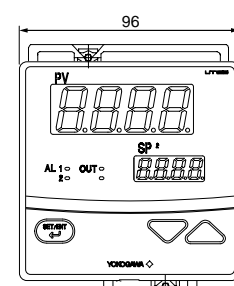
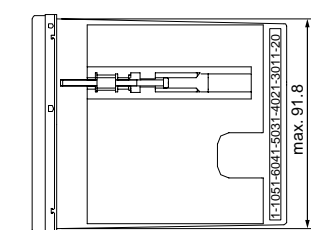

2. Side-by-side Close Mounting

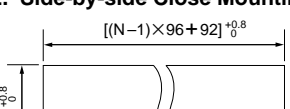

N is the number of controllers.
If N ≥ 5, then measure the actual length.

NOTE

Splash-proof construction is not available when the side-by-side close mounting method shown in the above figures, is chosen for any of the controllers.

■ Mounting the Controller

UT150

[How to remove the bracket]
To move the bracket, push down the center of the upper and lower parts of the controller softly. The bracket is released from the latch.

UT152, UT155

5. Wiring



- Before you start wiring, turn off the power source and use a tester to check that the controller and cables are not receiving any power in order to prevent electric shock.
- For safety, be sure to install a circuit breaker switch (of 5A and 100V AC or 220V AC, and that conforms to IEC60947) near the instrument so as to be operated easily, and clearly indicate that the device is used to de-energize the instrument.
- Wiring should be carried out by personnel with appropriate electrical knowledge and experience.



- Use a single-phase power source. If the source has a lot of noise, use an isolation transformer for the primary side and a line filter (we recommend TDK's ZAC2205-00U product) for the secondary side. When this noise-prevention measure is taken, keep the primary and secondary power cables well apart. Since the controller has no fuse, be sure to install a circuit breaker switch (of 5A and 100V AC or 220V AC, and that conforms to IEC standards) and clearly indicate that the device is used to de-energize the controller.
- For thermocouple input, use shielded compensating lead wires. For RTD input, use shielded wires which have low resistance and no resistance difference between the 3 wires. See the table given later for the specifications of the cables and terminals and the recommended products.
- The control output relay cannot be replaced even though it has a limited service life (100,000 relay contacts for the resistance load). Thus, an auxiliary relay should be used so that the load can be turned on and off.
- When using an inductive load (L) such as an auxiliary relay and solenoid valve, be sure to insert a CR filter (for AC) or diode (for DC) in parallel as a spark-rejecting surge suppressor to prevent malfunctions or damage to the relay.
- When there is the possibility of being struck by external lightning surge, use the arrester to protect the instrument.

Cable Specifications and Recommended Products

Power supply and relay contact output	600V vinyl insulated wire/cable, JIS C3307, 0.9 to 2.0mm ²
Thermocouple input	Shielded compensating lead wire, JIS C1610
RTD input	Shielded wire (3-wire), UL2482 (Hitachi cable)
Other signals	Shielded wire

Recommended Terminals

Use M3.5 screw-compatible crimp-on terminals with an insulating sleeve, as shown below.

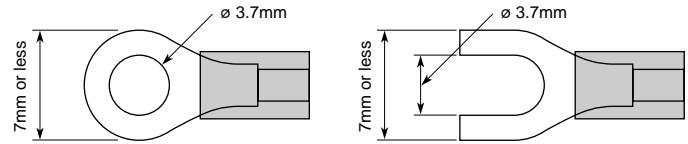

Always fix a terminal cover bracket to the UT150 controller before wiring if an optional anti-electric-shock terminal cover (part number: L4000FB) is used.



Two types of optional anti-electric-shock terminal covers (part numbers T9115YE and T9115YD) are available for the UT152 and UT155 controllers, respectively.

UT150 Terminal Arrangement (Standard type)

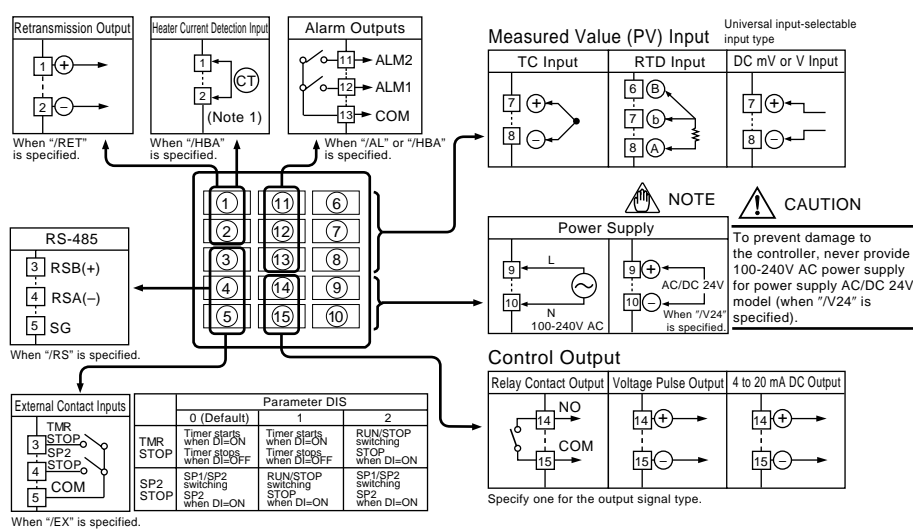

(Heating/cooling Type)

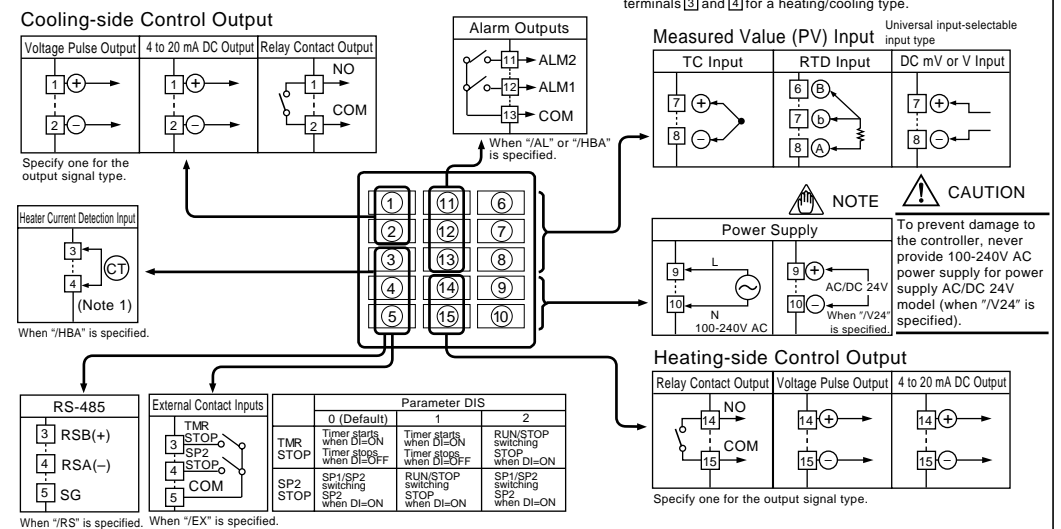

UT152/UT155 Terminal Arrangement (Standard Type)

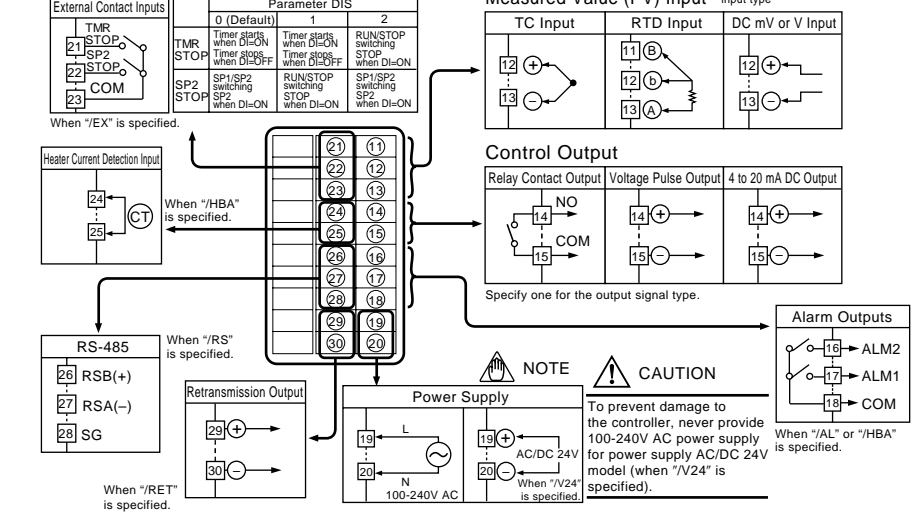

(Heating/cooling Type)

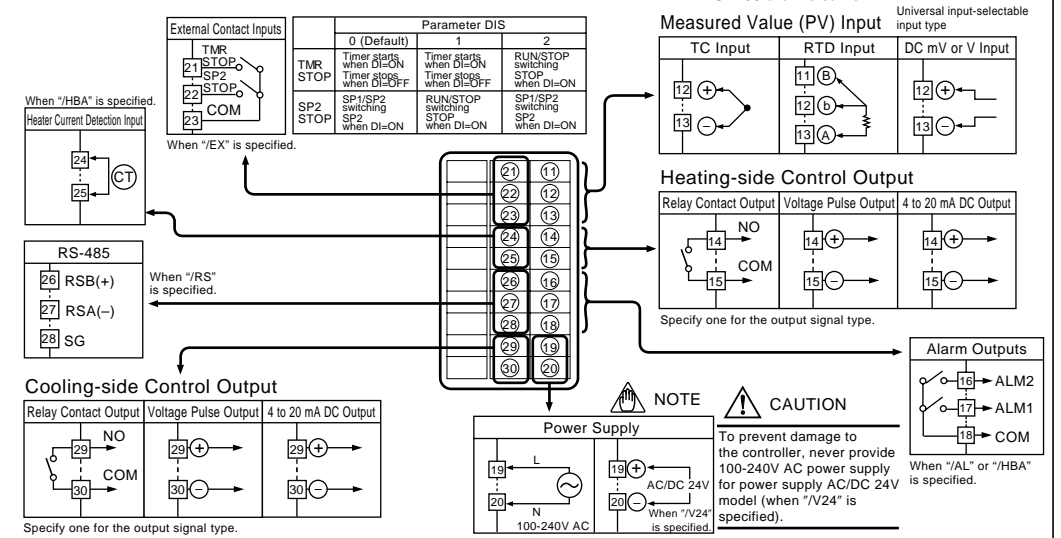

6. Hardware Specifications

Measured Value (PV) Input

- Input: 1 point
- Input type: Universal; can be selected by software
- Input accuracy: at 23 ±2°C ambient temperature)
 - Thermocouple: ±2°C
 - However,
 - ±4°C for thermocouple input -200 to -100°C
 - ±3°C for thermocouple input -100 to 0°C
 - ±5°C for type R and S (±9°C for 0 to 500°C)
 - ±9°C for type B (accuracy is not guaranteed for 0 to 400°C)
 - RTD: ±1°C ±1digit
 - Voltage(mV, V) : ±0.3%
 - Sampling period for measured value input: 500ms
 - Burn-out detection: Functions for thermocouple or RTD input (burn-out upscale only; cannot be switched off)
 - Input resistance: 1MΩ or greater for thermocouple or DC mV input. Approx. 1MΩ for DC V input
 - Maximum allowable signal source resistance : 250Ω for thermocouple or DC mV input 2kΩ for DC V input
 - Maximum allowable wiring resistance for RTD input: 10Ω/wire (The resistance values of three wires must be the same.)
 - Allowable input voltage: ±10V DC for thermocouple or DC mV input ±20V DC for DC V input
 - Noise rejection ratio: Normal mode noise: Min. 40dB (50/60Hz) Common mode noise: Min. 120dB (Min. 90dB for DC V input)
 - Error of reference junction compensation: ±1.5°C (at 15-35°C) ±2.0°C (at 0-50°C)
- The reference junction compensation cannot be switched off.
- Applicable standards: Thermocouple and resistance temperature detector JIS/IEC/DIN (ITS90)

Control Output

- Output: 1 point (for standard type) or 2 points (for heating/cooling type)
- Output type: Choose one from (1) to (3) below:
 - Relay contact output
Contact capacity: 3A at 240V AC or 3A at 30V DC (with resistance load)
Note: The control output relay cannot be replaced by users.
 - Voltage pulse output
On voltage: 12-18V DC (load resistance: 600Ω or greater)
Off voltage: 0.1V DC or less (short-circuit current: approx. 30mA)
 - Current output
Output signal: 4 to 20mA
Maximum load resistance: 600Ω
Output accuracy: ±0.3% of span (at 23±2°C ambient temperature)

Alarm Functions

- Alarm Functions (Option Code /AL or /HBA)
 - Alarm types: 22 types (waiting action can be set by software): PV high limit, PV low limit, Deviation high limit, Deviation low limit, De-energized on deviation high limit, De-energized on deviation low limit, Deviation high and low limits, High and low limits within deviation, De-energized on PV high limit, De-energized on PV low limit, Fault diagnosis output, FAIL output
 - Alarm output: 2 relay contacts
Relay contact capacity: 1A at 240V AC or 1A at 30V DC (with resistance load)
Note: The alarm output relays cannot be replaced by users.

Heater Disconnection Alarm (Option Code /HBA)

- The heater disconnection alarm is available when time-proportional PID control or on/off control is selected.
 - Heater current setting range: 1 to 80A
 - Alarm output: 1 relay contact (The terminals are the same as those of the /AL option.)
 - On time of burn-out detection: Min. 0.2 second
 - Sensor: CTL-6-S-H or CTL-12-S36-8 (URD Co., Ltd.)
To be purchased separately.

Timer Function (Option Code /AL/EX or /HBA/EX)

- The output contact status changes when the preset time has passed since external contact (TMR) turned on. The contact action can be selected by software from:
 - Make contact—the contact closes upon time-up.
 - Break—the contact opens upon time-up.
- Input contact type: See **Contact Inputs** below.

Retransmission Output

- The retransmission output is provided only when the /RET option is specified, but is not available for the heating/cooling type.
 - Output signal: Measured value in 4-20mA DC
 - Maximum load resistance: 600Ω
 - Output accuracy: ±0.3% of span (at 23±2°C ambient temperature)

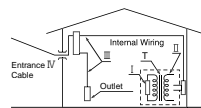

Contact Inputs

- The contact inputs are provided only when the /EX option is specified.
 - Functions: (1) SP1/SP2 switching (2) Starting a timer (See the **Alarm Functions**) (3) RUN/STOP switching
Can be selected by parameter DIS.
 - Input: 2 points (with the shared common terminal)
 - Input type: Non-voltage contact or transistor contact input
 - Contact capacity: At least 12V/10mA
 - On/off judgment: On state for 1kΩ or less; off state for 20kΩ or greater

Communication Function

- The communication function is provided only when the /RS option is specified. (For details, read the instruction manual of the communications functions IM 05C01E12-10E.)

Communication Protocol

- Personal computer link: Used for communication with a personal computer, or UT link module of the FA-M3 controller (from Yokogawa Electric Corporation).
- Ladder communication: Used for communication with a ladder communication module of the FA-M3, or a programmable controller of other manufacturers.
- MODBUS communication: Used for communication with equipment featuring the MODBUS protocol.
- Communication Interface
 - Applicable standards: Complies with EIA RS-485
 - Number of controllers that can be connected: Up to 31
 - Maximum communication distance: 1,200m
 - Communication method: Two-wire half-duplex, start-stop synchronization, non-procedural
 - Baud rate: 2400, 4800, or 9600 bps

Safety and EMC Standards

- Safety: Compliant with IEC/EN61010-1: 2001, approved by CSA1010, approved by UL508. Installation category: CAT. II (IEC/EN61010, CSA1010) Pollution degree: 2 (IEC/EN61010, CSA1010) Measurement category: I (CAT. I: IEC/EN61010) Rated measurement input voltage: 10V DC max. (across terminals), 300V AC max. (across ground) Rated transient overvoltage: 1500V (Note)
Note: It is a value on the safety standard which is assumed by IEC/EN61010-1 in measurement category I, and is not the value which guarantees an apparatus performance. Caution: This equipment has Measurement category I, therefore do not use the equipment for measurements within measurement categories II, III and IV.
- EMC standards: Complies with EN61326. The instrument continues to operate at a measuring accuracy of within ±20% of the range during tests.

Measurement category	Description	Remarks
I CAT. I	For measurements performed on circuits not directly connected to MAINS.	
II CAT. II	For measurements performed on circuits directly connected to the low voltage installation.	Appliances, portable equipments, etc.
III CAT. III	For measurements performed in the building installation.	Distribution board, circuit breaker, etc.
IV CAT. IV	For measurements performed at the source of the low-voltage installation.	Overhead wire, cable systems, etc.

Construction, Mounting, and Wiring

- Construction: Dust-proof and drip-proof front panel conforming to IP65 [Model UT150] and IP55 [Models UT152 and UT155]. For side-by-side close installation the controller loses its dust-proof and drip-proof protection.
 - Casing: ABS resin and polycarbonate
 - Case color: Black
 - Mounting: Flush panel mounting
 - Terminals: Screw terminals

Environmental Conditions

- Normal Operating Conditions
 - Warm-up period: At least 30 minutes
 - Ambient temperature: 0-50°C (0-40°C when mounted side-by-side)
 - Rate of change of temperature: 10°C/h or less
 - Ambient humidity: 20-90% RH (no condensation allowed)
 - Magnetic field: 400A/m or less
 - Continuous vibrations of 5 to 14Hz: Amplitude of 1.2mm or less
 - Continuous vibrations of 14 to 150Hz: 4.9m/s² (0.5G) or less
 - Short-period vibrations: 14.7m/s² (1.5G) for 15 seconds or less
 - Shock: 98m/s² (10G) for 11 milliseconds or less
 - Mounting angle: Upward incline of up to 30 degrees; downward incline is not allowed.
 - Altitude: 2000m or less above sea level
- Maximum Effects from Operating Conditions
 - Temperature effects
 - Thermocouple, DC mV and DC V input: ±2μV/°C or ±0.02% of F.S./°C, whichever is the larger
 - Resistance temperature detector: ±0.05°C/°C
 - Analog output: ±0.05% of F.S./°C
 - Effect from fluctuation of power supply voltage (within rated voltage range)
 - Analog input: ±0.2μV/V or ±0.002% of F.S./V, whichever is the larger
 - Analog output: ±0.05% of F.S./V

Transportation and Storage Conditions

- Temperature: -25 to 70°C
- Humidity: 5 to 95% RH (no condensation allowed)
- Shock: Package drop height 90cm (when packed in the dedicated package)

7. Key Operations

CAUTION

To prevent electric shock, the controller should be mounted on the panel so that you do not accidentally touch the terminals when power is being applied.

IMPORTANT

The temperature controller is shipped with the parameters set at the factory-set defaults. Check the default values against the "Parameter Lists" in the following page, and change the parameter settings that need to be changed.

This section explains how to set and register parameter values.

The procedure for changing SP (target setpoint) and A1 (alarm 1 setpoint) can be found on "Changing Target Setpoint (SP)" and "Changing Alarm 1 Setpoint (A1)," respectively. You can set the other parameters in the same way.

There are no setup displays for parameters specific to functions, such as the optional alarm output functions or heating/cooling control, if they were not selected at ordering.

The setting of some parameters (such as the control mode parameter CTL) determines whether the other parameters are displayed or not.

The flowchart below will help you understand how this works.

NOTE

At power-on, the temperature controller displays the operating display ①, but if the measured input range setting remains OFF, then "IN" appears. In this case, press the Δ key to display the measured input range code you want to use, then press the ENTER key to register it. (Refer to the flowchart below.)

- You can move between parameter setting displays using the ENTER key.
- To change the set value,
 - Change the display value with the ∇ or Δ key (the period flashes).
 - Press the ENTER key to register the setting.
- At the operating display ① or ②, pressing the ENTER key for at least 3 seconds retrieves the operating parameter setting display.
- At the operating parameter setting display, pressing the ENTER key for at least 3 seconds transfers back to the operating display ①. Registering the key-lock parameter LOC to "-1" retrieves the setup parameter setting display.
- At the setup parameter setting display, pressing the ENTER key for at least 3 seconds transfers back to the operating display ①.

Note: If you cannot change the parameter setting value, check the key-lock parameter (LOC) setting.

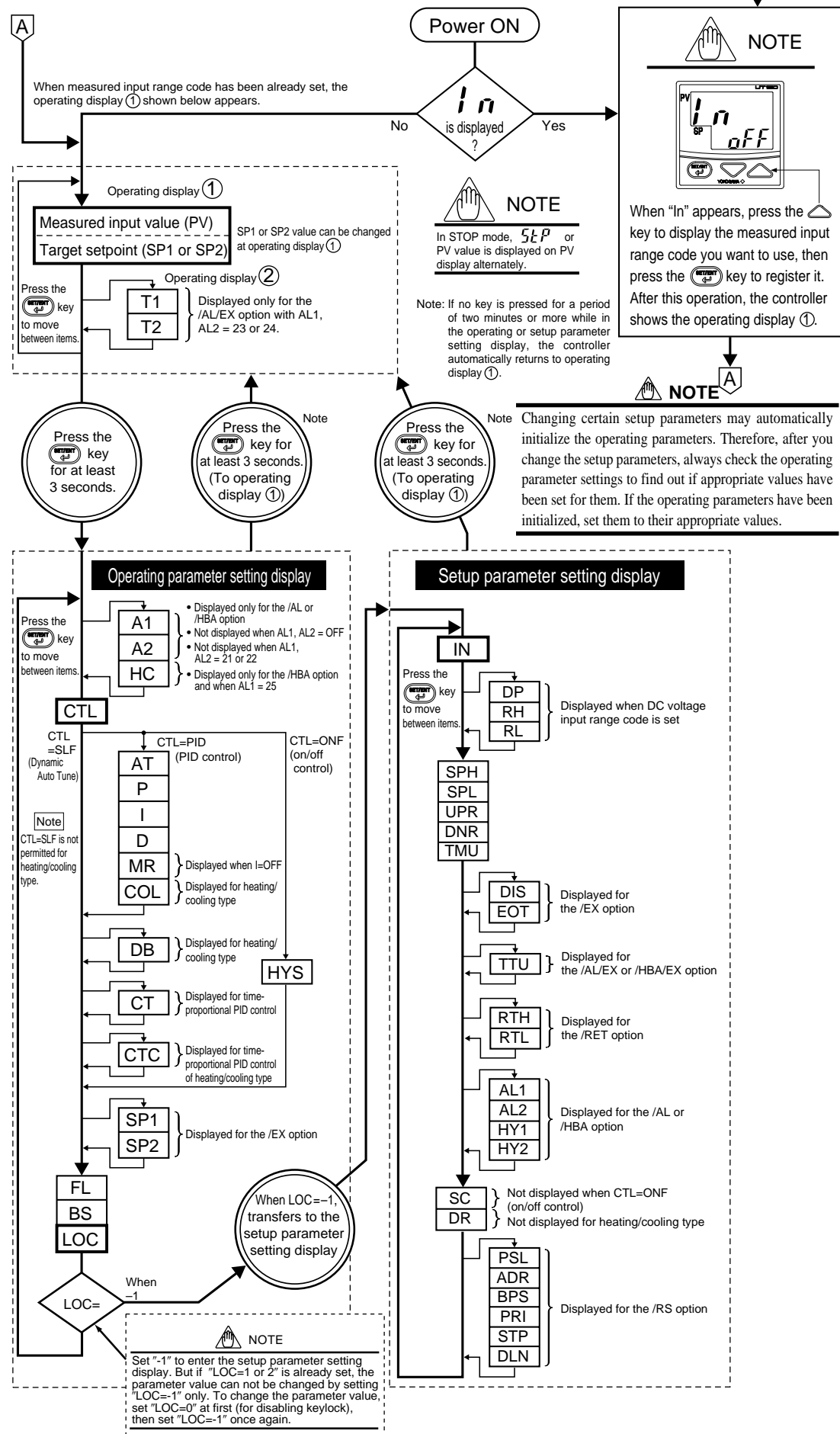

Changing Target Setpoint (SP)

The following instructions assume that the controller is already receiving power.

Step 1:

Confirm that the controller shows the operating display ① during normal operation (PV and SP are displayed on the indicators).

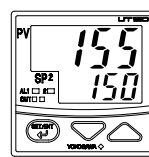

Step 2:

Press the Δ or ∇ key to change the displayed SP value to the required value. In this example, SP is changed to 200°C.



Step 3:

Press the ENTER key once to register the setting. The period goes out. SP is now changed.

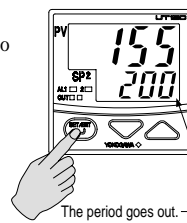

Changing Alarm 1 Setpoint (A1)

(This setpoint appears only if the /AL or /HBA option is specified.)

Step 1:

Confirm that the controller shows the operating display ① during normal operation (PV and SP are displayed on the indicators).

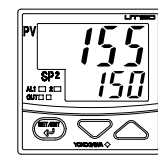

Step 2:

To enter the operating parameter setting display, press the ENTER key for at least 3 seconds. If your controller has the /AL or /HBA option, the display for the Alarm 1 setpoint (A1) appears. (If not, control mode (CTL) appears.)

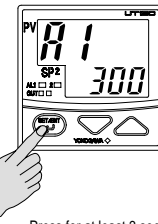

Step 3:

Press the Δ or ∇ key to change the current A1 value to a required value. In this example, A1 is changed to 200°C.

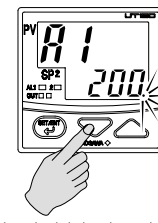

Step 4:

Press the ENTER key once to register the setting. The period goes out. A1 is now changed. Another press of the ENTER key calls up the Alarm 2 setpoint (A2) display. To return to the operating display ①, press the ENTER key for at least 3 seconds.

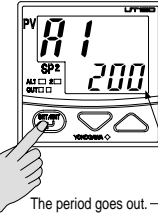

UT150/UT152/UT155 Measured Input Ranges

Input type	Range (°C)	Range code (°C)	Range (°F)	Range code (°F)
Thermocouple	K	-270 to 1370°C	-300 to 2500°F	31
		0.0 to 600.0°C	32.0 to 999.9°F	32
		0.0 to 400.0°C	32.0 to 750.0°F	33
		-199.9 to 200.0°C	-300 to 400°F	34
	J	-199.9 to 999.9°C	-300 to 2100°F	35
	T	-199.9 to 400.0°C	-300 to 750°F	36
	E	-199.9 to 999.9°C	-300 to 1800°F	37
	R	0 to 1700°C	32 to 3100°F	38
	S	0 to 1700°C	32 to 3100°F	39
	B	0 to 1800°C	32 to 3200°F	40
N	-200 to 1300°C	-300 to 2400°F	41	
L	-199.9 to 900.0°C	-300 to 1600°F	42	
U	-199.9 to 400.0°C	-300 to 750°F	43	
Platinel 2	0 to 1390°C	32 to 2500°F	44	
RTD	Pt100	-199.9 to 850.0°C	-199.9 to 999.9°F	45
		0.0 to 400.0°C	32.0 to 750.0°F	46
		-199.9 to 200.0°C	-300 to 400°F	47
		-199.9 to 99.9°C	-199.9 to 999.9°F	48
	JPt100	-199.9 to 500.0°C		19
	0 to 100mV	0.0 to 100.0		20
	0 to 5V	0.000 to 5.000		21
	1 to 5V	1.000 to 5.000		22
0 to 10V	0.00 to 10.00		23	
		User-scalable		

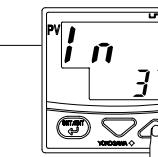

For example, to select thermocouple type E (°F), set the range code to 37.

8. Troubleshooting

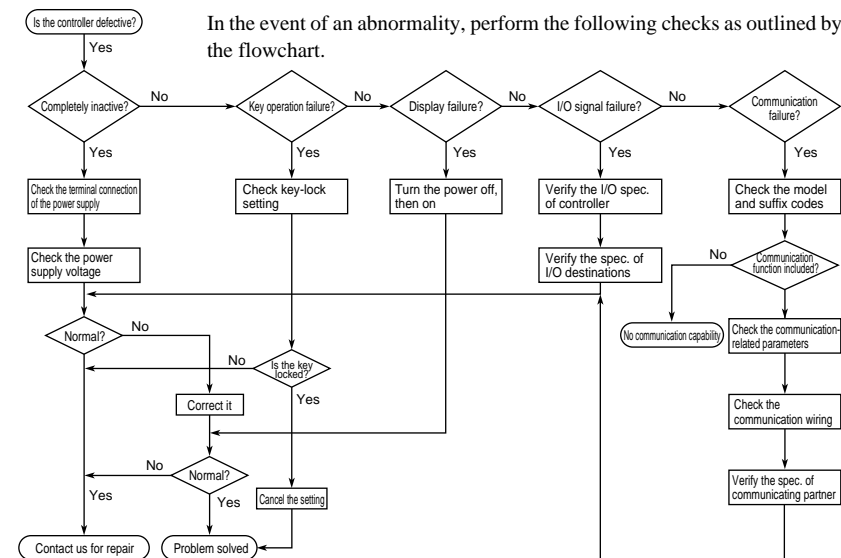

Error Display during Operation

(1) If the controller displays one of the following, carry out the appropriate remedy for the particular error.

Display	Error content	Remedy
PEr	P.Er The parameter is abnormal	Check the settings of all the parameters and set them at their proper values.
b.o	B.o Input burnout	Check the sensor wiring and correct it.
ooo	OOO PV over-scale (PV exceeds its effective range.)	Check the input type and range settings and correct them.
uuu	UUU PV under-scale (PV falls below its effective range.)	
Flashing period on PV display	Communication failure (for /RS option only)	Press any key to stop the flashing.

(2) The controller needs to be repaired if any of the indications in the table below appear.

Display	Error content	Display	Error content
Unknown (at power-on)	CPU failure	Flashing "Err" (at power-on)	RAM or ROM failure
All extinguished (at power-on)	Power source failure	Flashing "Err" (during operation)	A/D converter failure, RJC failure, or EEPROM failure
"Err" (at power-on)	Calibration abnormal		

When Power Failure Occurred during Operation

- Momentary power failures of less than 20ms (or less than 1ms when "/V24" is specified) have no effect on the controller operation (i.e., normal operation continues).
- For power failures longer than 20ms (or longer than 1ms when "/V24" is specified), however the status will be as follows. (The controller action at power recovery is the same as at power-on.)
 - Alarm action: Continues (but alarms with a waiting action enter the waiting state once)
 - Setting parameters: Maintained
 - Auto-tuning: Canceled

Alarm Function List

Alarm type	Action	Alarm type code	Alarm type	Action	Alarm type code
No alarm	OFF	1	De-energized on deviation low limit	Hysteresis Opn (on) → Cls (off)	6
PV high limit	Hysteresis Opn (off) → Cls (on)	11	De-energized on PV high limit	Hysteresis Cls (off) → Opn (on)	16
PV low limit	Hysteresis Cls (on) → Opn (off)	2	Deviation high and low limit	Hysteresis Opn (off) → Cls (on) → Opn (off)	7
Deviation high limit	Hysteresis Opn (off) → Cls (on)	3	Deviation within high- and low-limit	Hysteresis Opn (off) → Cls (on) → Opn (off)	8
Deviation low limit	Hysteresis Cls (on) → Opn (off)	4	De-energized on PV high limit	Hysteresis Cls (off) → Opn (on)	9
De-energized on deviation high limit	Hysteresis Cls (off) → Opn (on)	5	De-energized on PV low limit	Hysteresis Opn (on) → Cls (off)	10
Fault diagnosis alarm	The contact is closed at input burnout.	21	Break timer function	External contact (TMR) Opn → Cls → Opn	24
FAIL output	The output contact is opened in the following events: • Program error • ROM error • RAM error • power failure	22	Heater disconnection alarm	Opn (off) → Cls (on)	25
Timer function	External contact (TMR) Opn → Cls → Opn	23			

Note: The alarms numbered 1 to 10 have no waiting action, while alarms 11 to 20 have a waiting action. The waiting action turns off the PV and deviation alarms that occur from the start of the control operation until a stable state is reached.

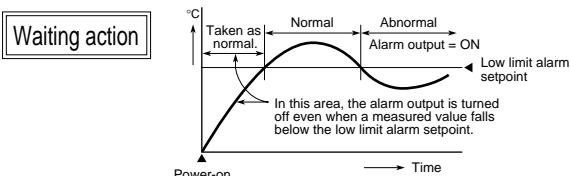

Description of Parameters

This section describes the parameter functions specific to the UT150/UT152/UT155 temperature controllers. (The functions described in other sections of this manual and the general functions are not discussed.)

Parameter	Function	Parameter	Function
Control mode	Select one from the following: a. Dynamic auto tune control (SLF) (See note) b. PID control (PID) c. On/off control (ONF) Note: Dynamic auto tune control is not available for heating/cooling control.	PV input bias	This function adds a bias value to the measured input value, and the result is used for display and control computation. $PV \text{ value inside the controller} = \text{measured input value} + PV \text{ bias}$
CTL	Read the section below this table to find out more about dynamic auto tune control.	BS	This function is useful for carrying out fine adjustment when the PV value is within the required accuracy but it differs from the value obtained by other equipment.
MR	You can set this parameter only for control without an integral action (when registered as CTL=PID and I=OFF). The controller outputs the manual reset (MR) value when PV=SP. For example, if you set MR=50%, the controller outputs (OUT) 50% when PV=SP.	Decimal point of measurement input	For DC voltage input, the input signal can be scaled for the particular engineering unit. For example, if you set the input type (IN) at range code 22, the initial range is 0.0 to 100.0. a. Using DP, set the decimal point position fit for the engineering unit you want to use. (In the example below, the 2 digits to the right of the decimal point.) b. Next, register the scale values of the measured input scale using RH and RL. (In the example below, RH=10.00 and RL=0.00)
COL	For heating/cooling control, you can set the ratio between the cooling-side output and heating-side output. For example, if you set COL=2.0 and the heating-side output is 10% at a certain deviation (SP-PV), then the cooling-side output will be 20% when the cooling-side also reaches that deviation.	DP	0.0 (1V) → 100.0 (5V) Initial scale
DB	You can only set a deadband for heating/cooling control. In a positive deadband, there are neither heating-side nor cooling-side outputs. In a negative deadband, there are both heating-side and cooling-side outputs, which overlap each other. 1. When the deadband of a heating/cooling type is positive (Proportional band [P] control) 2. When both the heating and cooling sides are under on-off control	RH, RL	0.00 (RL) → 10.00 (RH) Measured input scale (after being scaled)
HYS	For on/off control (CTL=ONF), you can set a hysteresis around the on/off point (SP) to prevent chattering.	SPH, SPL	Using the SPH and SPL parameters, you can limit the setting range of the target setpoint (SP) within the measured input range (scale). This function prevents SP from being mistakenly set at too large or too small a value (beyond the setting range).
CT, CTC	The cycle time is the period of on/off repetitions of a relay or voltage pulse output in time proportional PID control. The ratio of the ON time to the cycle time is proportional to the control output value.	UPR, DNR	To prevent a sudden change in SP, or to change SP at a constant rate, ramp-up and ramp-down rates can be set separately. This function operates at the following events. a. SP change b. SP1/SP2 switching c. Power-on At power-on, SP starts from the current PV value.
FL	This function should be used when the PV display value may fluctuate greatly, for example, when the measured input signal contains noise. The filter is of the first-order lag type, and FL sets the time constant. If a larger time constant is set, the filter can remove more noise.	HY1, HY2	The alarms are output as relay outputs. Since a relay has a limited life, excessive on/off actions will shorten the life of the alarm. To prevent this, you can set a hysteresis to prevent excessive on/off actions for both alarm 1 and alarm 2.
		SC	The SUPER function is effective in the following cases: a. An overshoot must be suppressed. b. The rise-up time needs to be shortened. c. The load often varies. d. SP is changed frequently. Note 1: The SUPER function will not work when on/off control is selected, or I or D constants is set at OFF in PID control. Note 2: For some types of systems, the SUPER function may not be so useful. If this is the case, turn off the function.

What is Dynamic Auto Tune Control?

Dynamic auto tune control is one of the features offered by the temperature controller. When the controller is turned on or the measured input value (PV) starts "hunting", this mode of control monitors the behavior of the PV and/or OUT (control output value) to automatically determine the optimum PID constants. This means that the PID constants may be changed automatically. If this is not desirable for your system, operate the controller in the normal "PID control". If you want to automatically determine the PID constants at the initial startup of the controller, first define the target setpoint (SP) and then turn the controller off once and then back on again. Do not use dynamic auto tune control for a system where there is interference or continual disturbances.

Parameter Lists

(1) Target Setpoint (SP) and Timer Setting 1 and 2

Numbers in () are the parameter setpoints that apply when the communication function is used. Ex. OFF(0), ON(1)

Code	Name	Setting range and unit	Default	User setting
(SP value display)	Target setpoint	Minimum value (SPL) to maximum value (SPH) of target setpoint range Unit: °C/°F	SPL	
T1	Timer setting 1	0.0 to 99.59 Unit: minutes and seconds or hours and minutes Set the timer time unit using parameter TTU.	0.00	
T2	Timer setting 2	For example, 15.25 sets 15 minutes and 25 seconds. (T1 is for AL1, and T2 is for AL2)	0.00	

(2) Operating Parameters : Parameters changed rather frequently during operation.

Code	Name	Setting range and unit	Default	User setting
A1	Alarm 1 setpoint	■ PV alarm Unit: °C/°F Setting range: minimum value to maximum value of measured input range (scale) ■ Deviation alarm Unit: °C/°F Setting range: -100 to 100% of the measured input range (scale) span	Max. value of measured input range (scale) (PV alarm)	
A2	Alarm 2 setpoint	■ Heater disconnection alarm Unit: A (ampere) Setting range: OFF(0), 1 to 80 (can be set for the alarm 1 setpoint only)	Min. value of measured input range (scale) (PV alarm)	
HC	Heater disconnection current measured value	"HC" is not a parameter to be set. The current value (0 to 80) of heater disconnection detector is displayed. Unit: A (ampere) Settings: When the display value is ---, the heater current is not being measured.		
CTL	Control mode	ONF(0): On/off control PID(1): PID control SLF(2): Dynamic auto tune control (cannot be set for heating/cooling control)	SLF(2) for standard type; PID(1) for heating/cooling type	
AT	Auto-tuning	OFF(0): Stop auto-tuning ON(1): Start auto-tuning	OFF(0)	
P	Proportional band	1°C/°F to the temperature that corresponds to 100% of the measured input range (scale) span	5% of measured input range (scale) span	
I	Integral time	1 to 3600 seconds; OFF(0): no integral action	240 seconds	
D	Derivative time	1 to 3600 seconds; OFF(0): no derivative action	60 seconds	
MR	Manual reset	-100 to 100%	50.0% for standard type; 0.0% for heating/cooling type	
COL	Cooling-side gain	0.01 to 9.99 times	1.00 times	
DB	Deadband	■ PID control Unit: °C/°F Setting range: -(proportional band setting) to +(proportional band setting) ■ On/off control Unit: °C/°F Setting range: -50 to +50% of measured input range (scale)span	0% of measured input range (scale) span	
HYS	Hysteresis for on/off control	0°C/°F to the temperature that corresponds to 100% of the measured input range (scale) span	0.5% of measured input range (scale) span	
CT	Control output cycle time	1 to 240 seconds	30 seconds	
CTC	Cooling-side control output cycle time	1 to 240 seconds	30 seconds	
SP1	Target setpoint 1	Minimum value (SPL) to maximum value (SPH) of target setpoint range Unit: °C/°F	SPL	
SP2	Target setpoint 2	There are also optional engineering units for voltage input.	SPL	
FL	PV input filter	OFF(0), 1 to 120 seconds	OFF(0)	
BS	PV input bias	-100 to 100% of measured input range (scale) span	0% of measured input range (scale) span	
LoL	Key lock	0: No key lock 1: Prevents operations from being changed except for the changing of SP in the operating display 2: Prevents all parameter changing operations -1: Set "-1" to enter the setup parameter setting display. But if "LOC=1 or 2" is already set, the parameter value can not be changed by setting "LOC=-1" only. To change the parameter value, set "LOC=0" at first (for disabling keylock), then set "LOC=-1" once again.	0	
LOC				

(3) Setup Parameters : Parameters rarely changed in normal use after once having been set.

Code	Name	Setting range and unit	Default	User setting
IN	Measured input type	1 to 23, 31 to 48 (See input range code list.) OFF(0): No input (If no input type is specified at the time of ordering, you must set the input type.)	OFF(0), or the input range code specified with order	
DP	Decimal point position of measured input	0: No decimal place (nnn) 1: One decimal place (nn.n) 2: Two decimal places (nn.nn) 3: Three decimal places (n.nnn)	1	
RH	Maximum value of measured input scale	(RL + 1) to 9999 (Displayed at voltage input)	100.0	
RL	Minimum value of measured input scale	-1999 to (RH - 1) (Displayed at voltage input)	0.0	
SPH	Maximum value of target setpoint range	(SPL+1°C) to the maximum value of the measured input range (scale); Unit: °C/°F	Maximum value of measured input range (scale)	
SPL	Minimum value of target setpoint range	Minimum value of measured input range (scale) to (SPH - 1°C) Unit: °C/°F	Minimum value of measured input range (scale)	
UPR	Setpoint ramp-up-rate	OFF(0) or a value from the minimum to the maximum value of the measured input range (scale) Unit: °C/min or °F/hour Set the ramp-rate time unit using parameter TMU.	OFF(0)	
DNR	Setpoint ramp-down-rate	OFF(0) or a value from the minimum to the maximum value of the measured input range (scale) Unit: °C/min or °F/hour Set the ramp-rate time unit using parameter TMU.	OFF(0)	
TMU	Setpoint ramp-rate time unit	0: °C or °F / hour 1: °C or °F / min	1	
DIS	DI-function selection	External Contact Inputs UT150 UT152 1: TMR STOP 2: SP2 STOP 3: SP1 STOP 4: COM 5: COM Parameter DIS 0: TMR STOP when Di=ON, SP2 STOP when Di=OFF, SP1 STOP when Di=ON 1: TMR STOP when Di=ON, SP2 STOP when Di=OFF, SP1 STOP when Di=ON 2: RUN/STOP switching STOP when Di=ON	0	
EOT	Output in STOP mode	In STOP mode by contact input, fixed control output can be generated. 0: 0%; 1: 100%	0	
TTU	Timer time unit	0: hour:minute 1: minute:second	1	
RTH	Maximum value of retransmission output	Temperature input: Within measured input range Voltage input: RTL+1 digit to max. value of measured input (scale)RH1	Maximum value of measured input range (scale)	
RTL	Minimum value of retransmission output	Min. value of measured input (scale)RL to RTH-1 digit However, RTL<RTH	Minimum value of measured input range (scale)	
AL1	Alarm 1 type	OFF(0) or a value from 1 to 22 (see the table of alarm function list), and either 23 or 24 (if the timer function [EX option] is included), and 25 (if the heater disconnection function [HBA option] is included)	1 (PV high limit alarm)	
AL2	Alarm 2 type	OFF(0) or a value from 1 to 22 (see the table of alarm function list), and either 23 or 24 (if the timer function [EX option] is included)	2 (PV low limit alarm)	
HY1	Alarm 1 hysteresis	0 to 100% of measured input range (scale) span Unit: °C/°F	0.5% of measured input range (scale) span	
HY2	Alarm 2 hysteresis	0 to 100% of measured input range (scale) span Unit: °C/°F	0.5% of measured input range (scale) span	
SC	SUPER function	ON(1): Uses the SUPER function OFF(0): Does not use SUPER function Note: Not displayed when on/off control	OFF(0)	
DR	Direct/reverse action	0: Reverse action 1: Direct action Note: Not displayed for heating/cooling type	0	
PSL	Protocol selection	0: PC-link communication 1: PC-link communication with sum check 2: Ladder communication 3: MODBUS in ASCII mode 4: MODBUS in RTU mode	0	
ADR	Controller address	1 to 99 However, the number of controllers that can be connected per host device is 31 at the maximum.	1	
BPS	Baud rate	2.4(0): 2400 bps 4.8(1): 4800 bps 9.6(2): 9600 bps	9.6(2)	
PRI	Parity	NON(0): Disabled EVN(1): Even parity ODD(2): Odd parity	EVN(1)	
STP	Stop bit	1 or 2 bits	1 bit	
DLN	Data length	7 or 8 bits • 8 bits when ladder, MODBUS (RTU) • 7 bits when MODBUS (ASCII)	8 bits	



To use dynamic auto tune control,
(1) be sure to turn on the final control element, such as a heater, before starting the control, and
(2) make sure the controlled loop is a closed loop.
If you do not follow these precautions, improper PID constants may be written into the controller. If this occurs, carry out the following:
• Set the parameter CTL at PID.
• Set the PID constants at the factory-set defaults (P = (upper range-limit - lower range-limit) × 5%; I = 240 s.; and D = 60 s.)
• Set the parameter CTL at SLF.
If the control still doesn't work properly, stop using the dynamic auto tune control function. Change the parameter CTL setting to PID and execute auto-tuning to obtain the PID constants.