

TEMI880

- Color type



TEMI850

- Mono type



INSTRUCTION MANUAL

TEMPERATURE • HUMIDITY
PROGRAMMABLE CONTROLLER

Contents

1 Installation Manual	
1.1 Introductions	1
1.2 Package checklist	3
1.3 Installation	5
1.4 Wiring	9
2 User Manual	
2.1 Setup Button	18
2.2 Input Setting Value	20
2.3 Block diagram of the basic processing	21
2.4 Initial Screen	22
2.5 Main Screen	23
2.6 Operation Screen	24
2.6.1 Program Stop Screen	24
2.6.2 Program Run Screen	26
2.6.3 Fix Stop Screen	29
2.6.4 Fix Run Screen	30
2.7 Operation Setting Screen	31
2.8 Reserve Setting Screen	33
2.9 Graph Setting Screen	34
2.10 Pattern Setting Screen	36
2.10.1 Edit Pattern Screen	37
2.10.2 Repeat Setting Screen	40
2.10.3 Edit File Screen	42
2.10.4 Time Signal Setting Screen	43
2.10.5 Wait Operation Setting Screen	45
2.10.6 Pattern Name Setting Screen	47
2.11 Display Setting Screen	48
2.12 System Setting Screen	49
2.12.1 Input and Input Compensation Setting Screen	50
2.12.2 Control Output and Transmission Setting Screen	56
2.12.3 ON/OFF Signal and Inner Signal Setting Screen	60
2.12.4 PID Setting Screen	64
2.12.5 DO CONFIG Setting Screen	68
2.12.6 Alarm and DI Error Name Setting Screen	72
2.12.7 Communication Setting Screen	75
2.12.8 Initial Display and Status Display Lamp Setting Screen	76
2.13 Password Input Screen	78
▪ Simple Example	79
3 Parameter Setting Table	81
4 Communication Manual	
4.1 Communication Specification	90
4.2 Communication Terminal Arrangement	91
4.3 Communication Command	92
4.4 D-Register Explanation	100
▪ D-REGISTER Table	108

※ This manual is used for the common use of the TEMI880 and TEMI850(Marking is only used TEMI880).

1. Installation Manual

1.1 Introductions

Thank you for purchasing our Industrial Controller.

This manual explains suitable effective way of using and installing this product.



SYMBOL MARK

(1) This symbol is used for danger or warning.



(A) Product : Indicates an imminently hazardous situation which
If not avoided, will result in serious injury or out of order.

(B) Instruction Manual : Indicates an imminently hazardous situation which,
if not avoided, will result in serious injury or death.

(2) Ground



This symbol indicates that the terminal must be connected to ground prior
To operation of equipment.

(3) supplemental explanation



Draws attention to information essential for understanding the operations and features.

(4) See also



Give the reference locations for further information on the topic.



Regarding This Document

(1) Keep the manual for the last user who can get easy access to the manual.

(2) Make sure read this manual carefully and fully understand how to operate this product.

(3) This manual is intended to describe the functions of this product.

Samwontech Co., Ltd.(hereinafter simply referred to as We) does not guarantee the application
of these functions for any particular purpose.

(4) Redistribution & use this manual, with or without modification, are prohibited.

(5) The contents of this manual are subjected to change without prior notice.

(6) Every effort has been made to ensure accuracy in the preparation of this manual. However,
if any errors are found or important information be omitted, please contact your nearest
our representative or our sales office.

**CAUTION**

Regarding Protection, Safety and Prohibition

- (1) In the interest of protecting and ensuring the safety of this product and the system, which is controlled by this product, ensure that all instructions and precautions and precautions in this manual relating to safety are strictly adhered to in the use of this product.
- (2) Take note that if you handle the product in contradiction to these instructions, we does not guarantee safety.
- (3) If separate protection and/or safety circuits are to be installed for this product or the system, which is controlled by this product, ensure that such circuits are installed external to the product.
- (4) When you replace parts or consumables of the product, use those specified by us.

**CAUTION**

Limited Warranty

- (1) We make no warranties regarding the product except these mentioned in the Warranty.
- (2) In cases where the use of this product results in damage or loss to the user or a third party, we will not be responsible for any incidental or consequential damage or loss, or any damage or loss suffered by the user or third party resulting from a defect or defects in this product which could not be foreseen by us.

**CAUTION**

Warranty Policy

- (1) Warranty term is 1year parts and labor. We make warranties regarding the product only these mentioned in the WARRANTY.
- (2) A/S(After Sales Service) is needed actual expenses, after warranty period.
- (3) This warranty does not cover damage due to loss password, accident fire, flood and/or other acts of God: misuse, instability, improper installation, improper or unauthorized repairs, commercial adjustments which are explained in the instruction manual are not covered under the terms of this warranty. This warranty automatically will be voided for any unit found with a missing or altered serial number.
- (4) All warranty repairs must be performed by our authorized service center.

1.2 Package checklist

- ▶ Check the following when the controller opens from its package. Check the contents of the package against the Package List to make sure that all accessories are included in the package.

1.2.1 Model and Option codes

- ▶ Check the controller for any apparent physical damage.
Check point : Model number which is located right side of controller and left side of box.

Model	Option Code		UDC	Description	
TEMI880	-	1		Standard I/O BOARD (10 POINT) → Include 24V SMPS	
	-	2		Additional I/O BOARD (10 POINT)	
				0	RS232C (Standard)
				1	RS485 (Option)
				/UDC	UDC300 (Option)

☞ Standard is TEMI880-10 (Standard I/O Board + RS232C).

1.2.2 Components

- ▶ Check that the following items are provided.

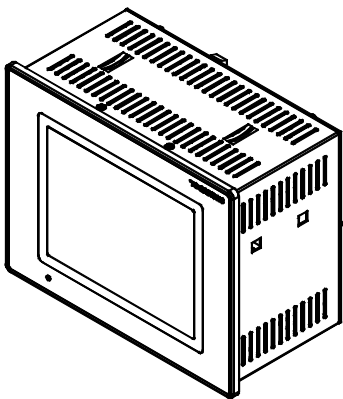
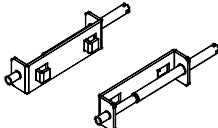
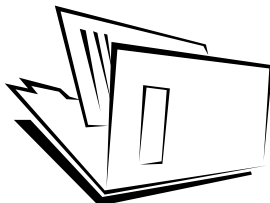
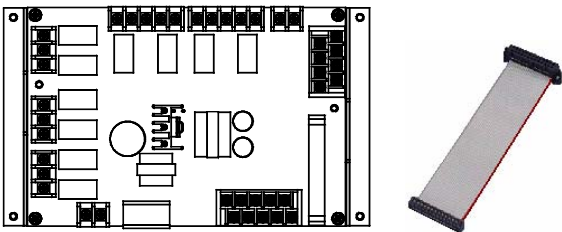
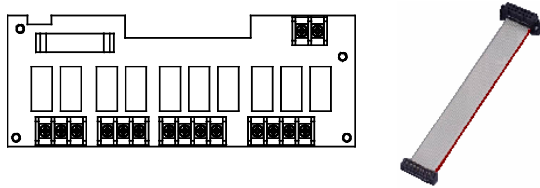
TEMI880	Brackets	Instruction Manual
		
I/O1 BOARD + 30 Pin Cable → Include 24V SMPS	I/O2 BOARD + 14 Pin Cable → If model is TEMI880-20 or -21	
		

1.2.3 Missed or damaged items

- ▶ If any of these items are missed or damaged, please contact your agent or sales representative for assistance.



Lifetime of the parts in the controller

- ▶ Check the lifetime for parts and we strongly recommend replace it if the lifetime is finished.

■ FUSE	SR-5:630mA/250VAC	: Semi-permanent
■ BACKLIGHT		: 10,000 ~ 15,000 hours
■ RELAY	JQ1P-DC24V	: Around ON/OFF 300,000 times
■ BATTERY	ER3VT(3.6V) 1/2AA	: Around 200,000 hours

- ☞ Danger of explosion if battery is incorrectly replaced. Replace only with the same or equivalent type.(SBAA02) Dispose of used battery separately from other waste.

1.3 Installation

1.3.1 Location and Environment



Important

- (1) NEVER touch the terminals or else you will get an electrical shock, if the unit is power-on.
- (2) To install the controller, select a location where :
 - No one may accidentally touch the terminals.
 - Mechanical vibrations are minimal.
 - Corrosive gas is minimal.
 - Temperature can be maintained between 10°C to 50°C and fluctuation is minimal.
 - Indoor use only.
 - Altitude is up to 2,000m.
 - No direct radiant heat or ultraviolet rays is present.
 - No magnetic disturbances are caused.
 - No wind blows against the terminal board(reference junction compensation element).
 - No dust or salt content.
 - No flammable materials are around.

☞ Although, the case of this system and the bezel are made of fire retardant SECC & ABC/PC respectively, do not install the system near inflammable materials. Also, avoid placing the system on inflammable materials directly.



Caution

- (1) There is little influence for electromagnetic fields and noise.
- (2) No moisture can get into the system.
- (3) Ambient temperature and humidity : 10~50°C, 20~90%RH.(At non-freezing status)
- (4) Storage temperature and humidity : -25~70°C, 5~95%RH.(At non-freezing status)
- (5) If you want to use it after keeping it under 0°C, you need to warm it up for 2 hours at room temperature before plugging it in and warm it up for 30 minutes after plugging it in.
Otherwise, it may not function normally and the product may be damaged.
- (6) Do not use around any machine, which heat up.
- (7) Avoid installing it with the front facing slant.
- (8) Transient over voltage category is category II.
- (9) Applicable rated pollution degree is pollution degree II.
- (10) Before starting wiring, be sure to turn off the system or else you will get an electrical shock.
- (11) Install the guard panel under the controller for your safety and installation with easy.
- (12) The I/O relay board must be installed inside of Temperature & Humidity Chamber.
- (13) The I/O relay board must be tied up with 4 pieces of bolt and nut at the 4 holes on the I/O relay board.

1.3.3 External and Panel Cutout Dimensions

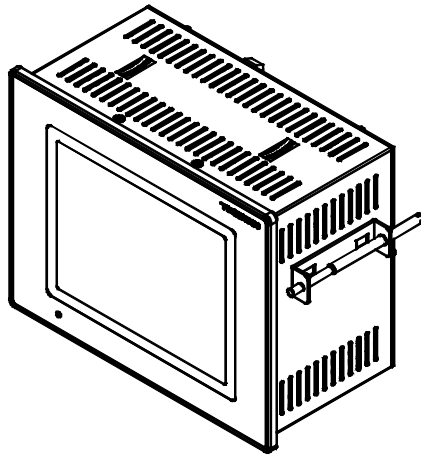
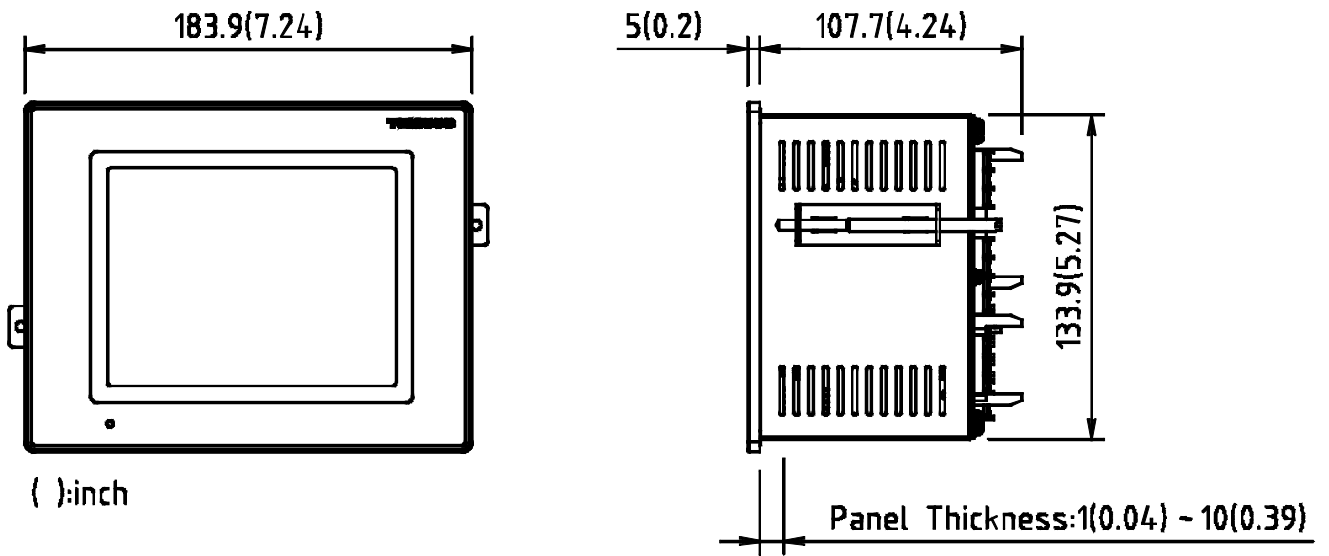

1.3.4 PANEL CUTTING

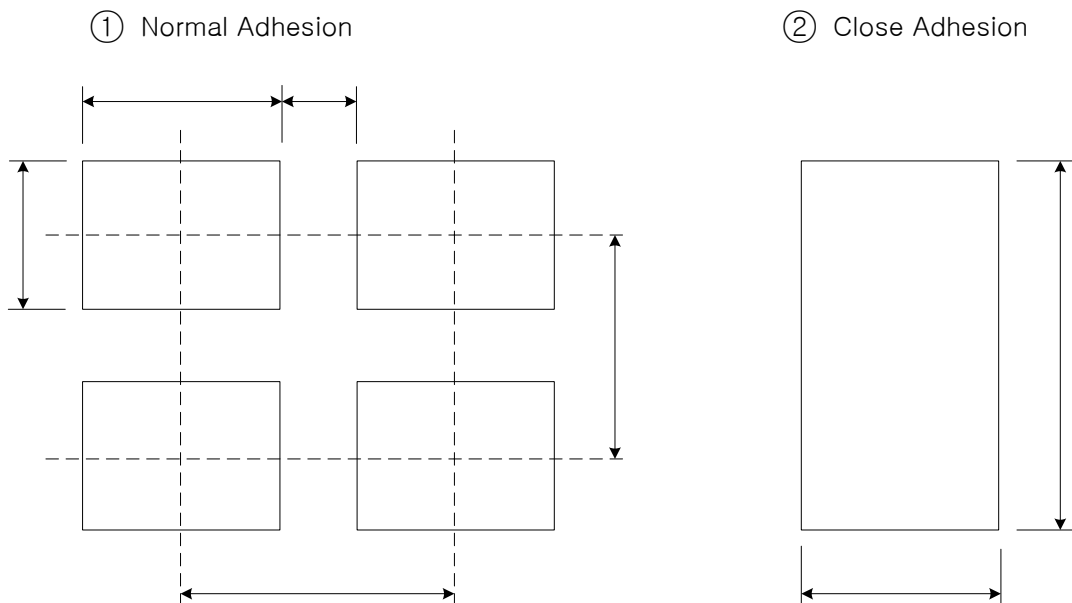

1.3.5 Installation (Mount)

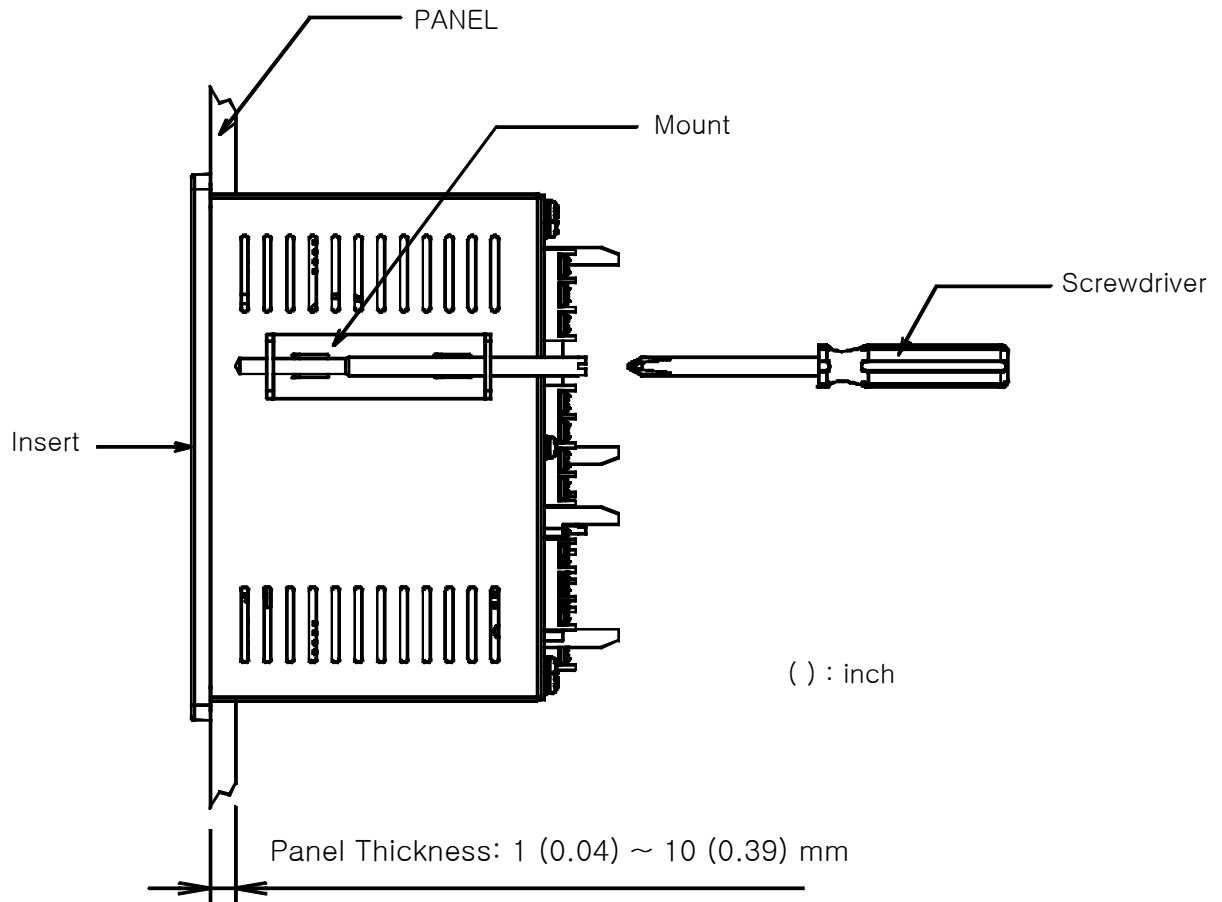

- ① Cut the mounting panel as Section.(See [1.3.4. PANEL CUTTING](#))
- ② Insert the unit from its back terminal board side.
- ③ Attach the left and right brackets to the unit to fix the unit to the mounting panel. (use screwdriver)

**CAUTION(Mount)**

- ▶ Do not tighten the mounting screw excessively, the unit case or bracket may be damaged.

1.3.6 Installation (Wiring for ground)

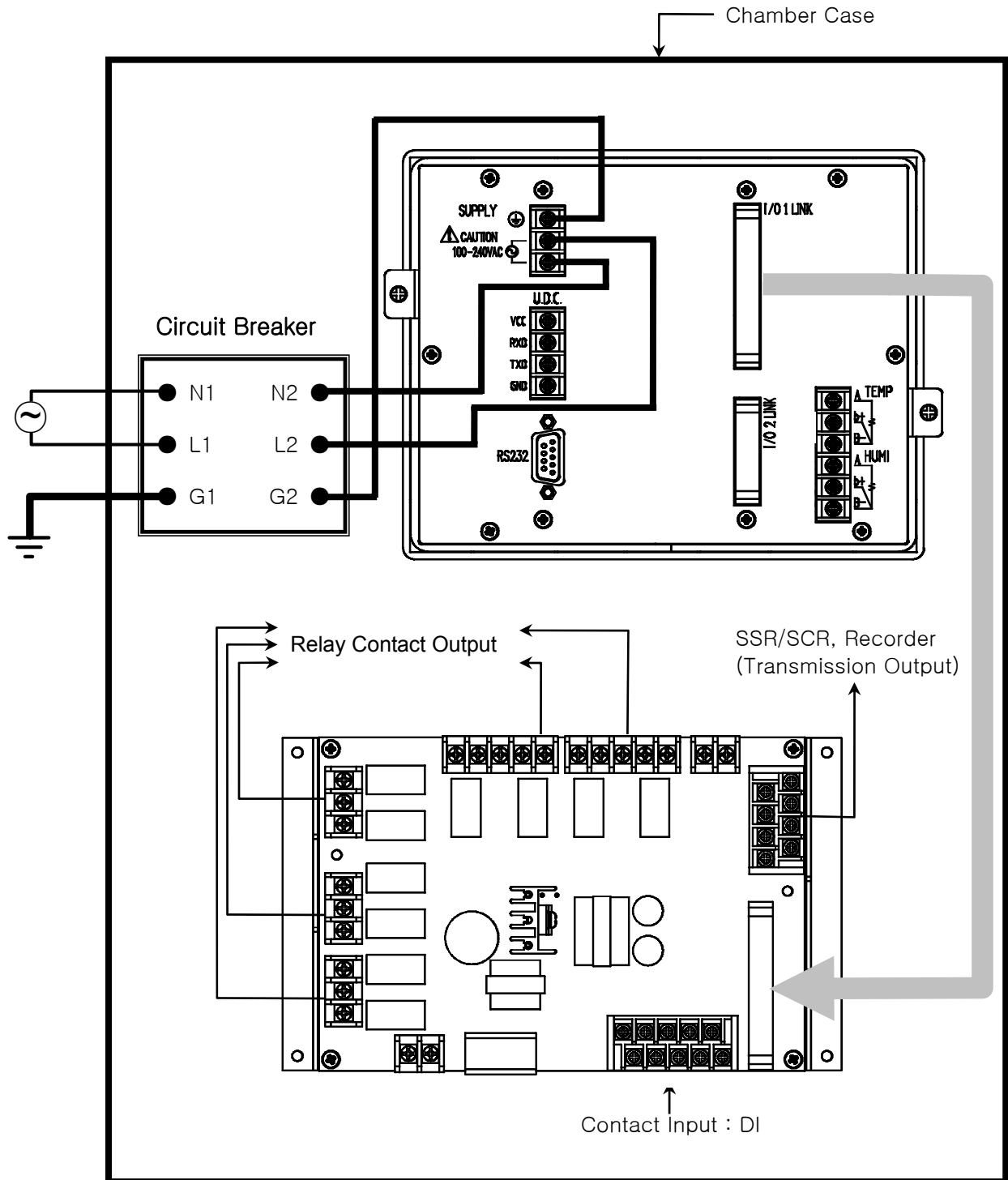

CAUTION(Wiring for ground)

- ▶ Make sure ground with Temp. and Humi. chamber case when install power injection.
- ▶ Make sure wiring of ground power source with circuit breaker in the Temp. & Humi. chamber.
- ▶ Make sure wiring of ground with controller circuit breaker in Temp. & Humi. chamber.

1.4 Wiring



CAUTION (Wiring)

- ▶ Before carrying out wiring, turn off the power to the controller and check that the cables to be connected are not alive with a tester or the like because there is a possibility of electric shock. Person who have basic electrical knowledge and practical experience must carry out wiring.
- ▶ The controller must be wired directly from circuit breaker output on inside of temperature & humidity chamber for avoid damage of controller or temperature & humidity chamber.

1.4.1 How to connect wires

1.4.1.1 Applicable power source cable

- ▶ Vinyl insulation cable KSC 3304 0.9~2.0 mm²

1.4.1.2 Applicable tightening terminal

- ▶ Please use-tightening terminal with insulating sleeve for M3.5 screws as shown in the following Figure :

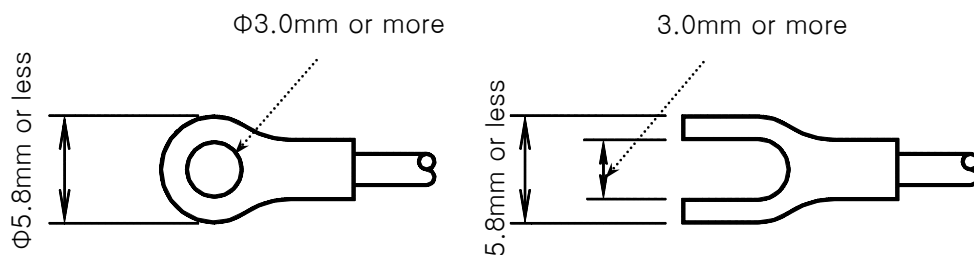

1.4.1.3 Noise rejections

■ Reason making noise

- (1) Relay and relay contact point
- (2) Solenoid coil, solenoid valve
- (3) Power source line
- (4) Inductive load
- (5) Inverters
- (6) Commutators of motor
- (7) Phase-angle SCR
- (8) Wireless communication
- (9) Welder
- (10) High-tension igniter, etc.

■ Solutions





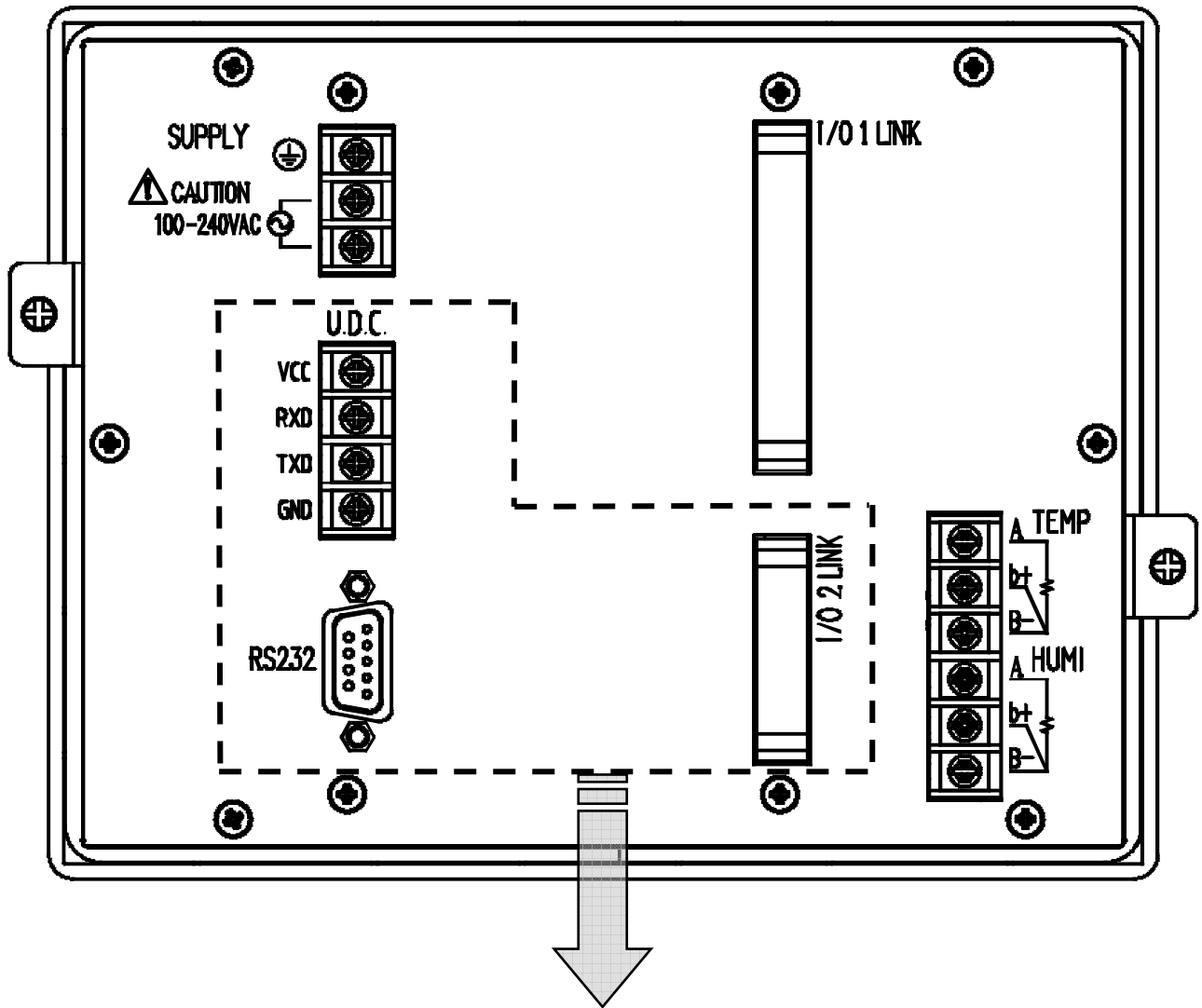

When wiring, comply with the following to protect the controller from noise sources :

- (1) Keep away the cables to the input circuit from the power supply circuit or the grounding circuit as much as possible.
- (2) Using a shielded cable is effective in avoiding noise from electrostatic induction. Connect a Shielded cable to the grounding terminal as required. Avoid two-point grounding.
- (3) To avoid noise from electromagnetic induction, it is relatively effective to mutually twist the input cables at regular short intervals.

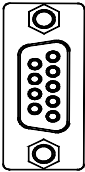
1.4.2 Terminal wiring diagram

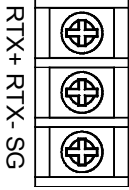
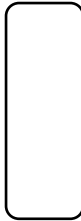
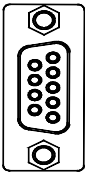
1.4.2.1 TEMI880 Body Terminal

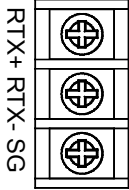

STANDARD : TEMI880-10(RS232C + I/O1)	OPTION1 : TEMI880-11(RS485 + I/O1)
 RS232 	 RS485 RTX+ RTX-SG 
Additional UDC Option : TEMI880-10/UDC	Additional UDC Option : TEMI880-11/UDC
OPTION2 : TEMI880-20(RS232C + I/O1 + I/O2)	OPTION3 : TEMI880-21(RS485 + I/O1 + I/O2)
 RS232  I/O1 LINK  I/O2 LINK	 RS485 RTX+ RTX-SG  I/O1 LINK  I/O2 LINK
Additional UDC Option : TEMI880-20/UDC	Additional UDC Option : TEMI880-21/UDC

1.4.2.2 I/O1 RELAY BOARD

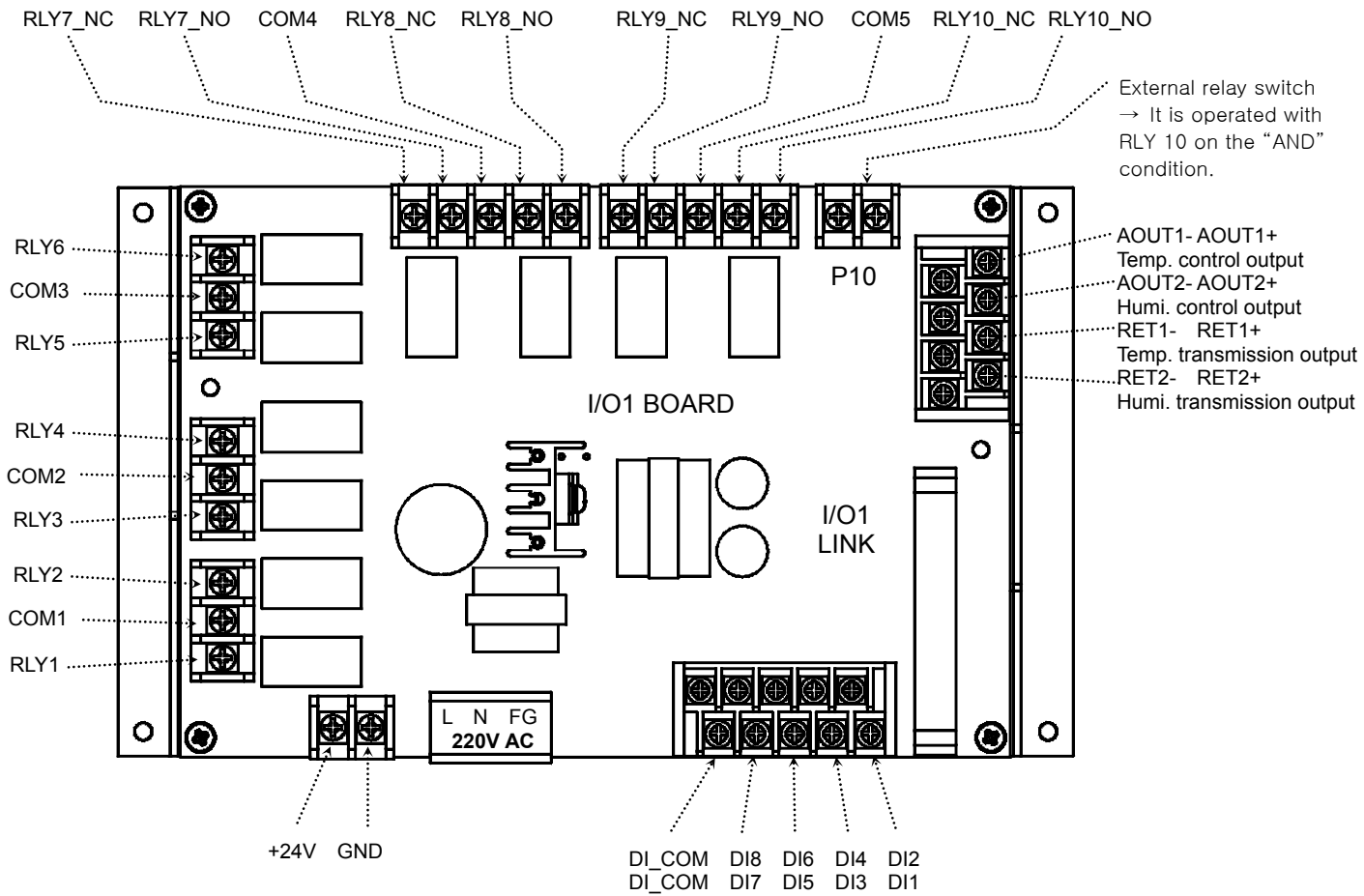

1.4.2.3 I/O2 RELAY BOARD

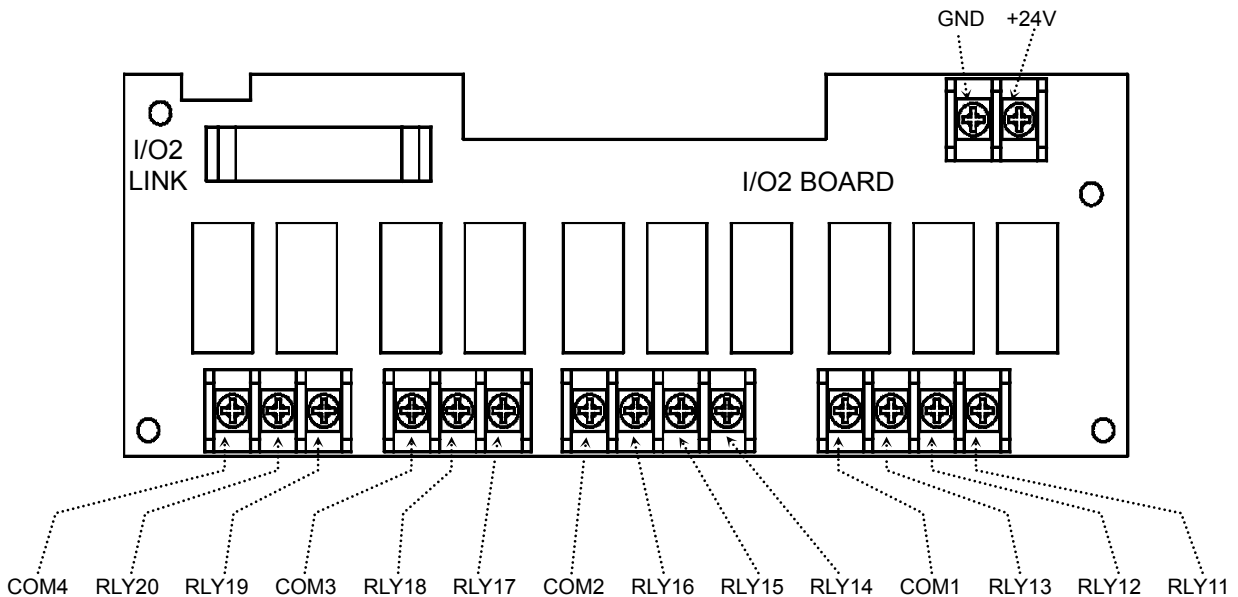

1.4.2.4 Grounding and Power Wiring

- ▶ Use a cable 2 mm² or more thick for grounding with class 3 grounding(grounding resistance a 100Ω or less) or higher. Do not extend the grounding cable over 20m.
- ▶ Ground from the ground terminal with a one-point contact. Do not wire between ground terminals.
- ▶ Use appropriate cables equivalent to vinyl insulation cable(KSC 3304) or more.

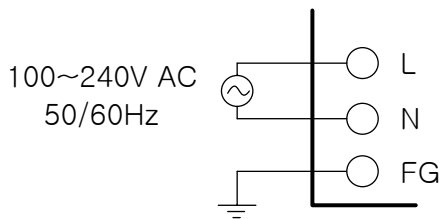

Class 3 Ground



Ground FRAME GROUND(FG) Exactly.

1.4.2.5 Analog Input



CAUTION

- ▶ Before starting analog input wiring, be sure to turn off the system or else you will get an electrical shock.
- ▶ When connection, do not mix up the input polarity. Connecting with the wrong polarity can cause the unit to malfunction.
- ▶ For input wiring, use a shielded cable. Ground the shield at one point and grounding circuits as possible.

Resistance Temperature Detector(RTD) Input

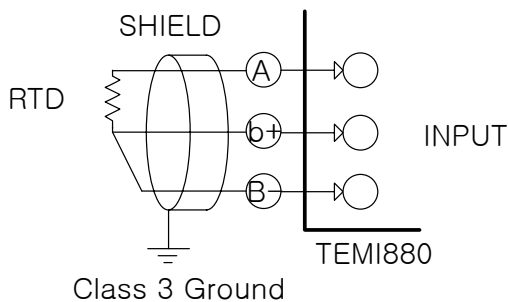

DC Voltage Input

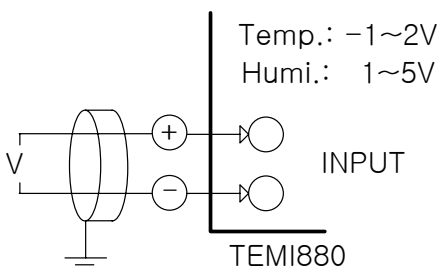

Temp.: -1~2V
Humi.: 1~5V

DC Current Input

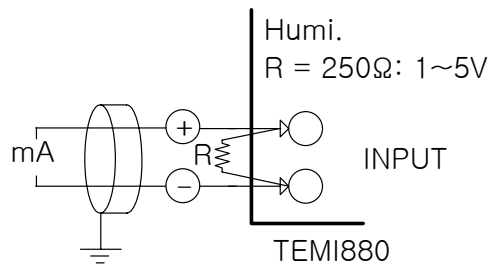

Humi.
R = 250Ω: 1~5V

1.4.2.6 Control Output and Transmission Output Wiring

CAUTION  **CAUTION**

- ▶ Before starting control output and transmission output wiring, be sure to turn off the system, or else you will get an electrical shock.
- ▶ When connecting, do not mix up the input polarity, Connecting with the wrong polarity can cause serious accidents.
- ▶ For input wiring, use a shielded cable. Ground the shield at one point.

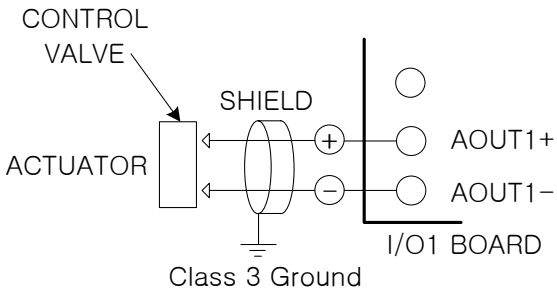
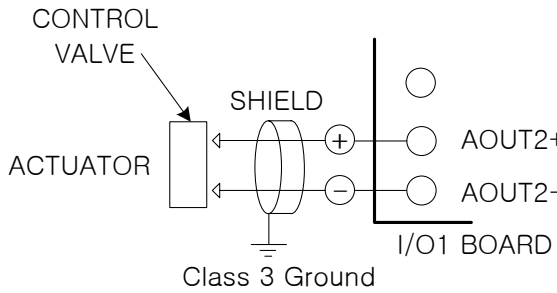
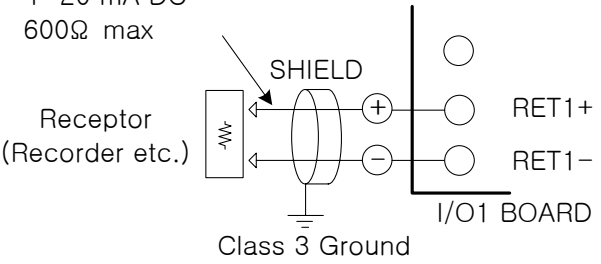
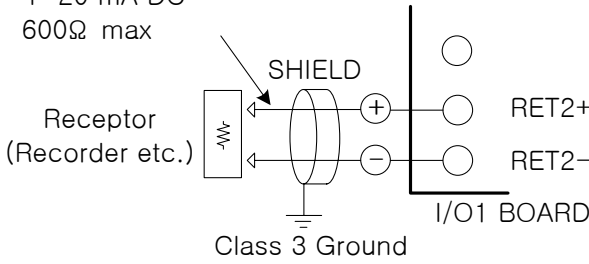
Temp. Control Output Wiring(SSR/4~20mA)	Humi. Control Output Wiring(SSR/4~20mA)
 <p>SSR : 12V DC min, 600Ω min SCR : 4~20mA DC min, 600Ω max</p>	 <p>SSR : 12V DC min, 600Ω min SCR : 4~20mA DC min, 600Ω max</p>
Temp. Transmission Output Wiring(4~20mA)	Humi. Transmission Output Wiring(4~20mA)
<p>4~20 mA DC 600Ω max</p> 	<p>4~20 mA DC 600Ω max</p> 

1.4.2.7 External Contact Output(RELAY) Wiring

CAUTION  **CAUTION** ► Before carrying out wiring, turn off the power to the controller and check that the cables to be connected are not alive with a tester because there is a possibility of electric shock.

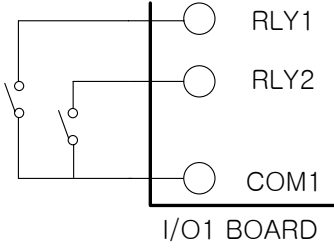
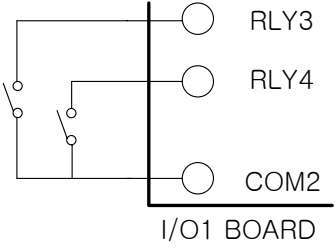
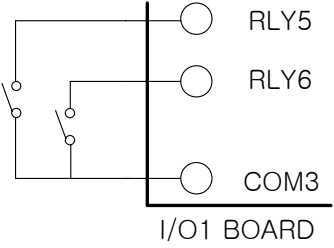
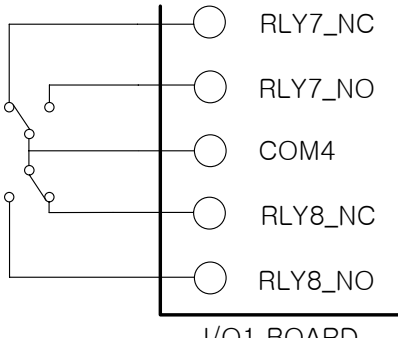
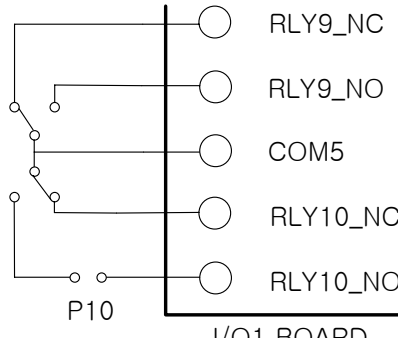
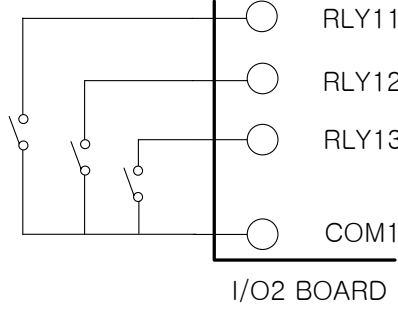
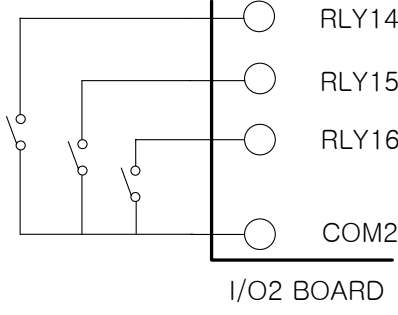
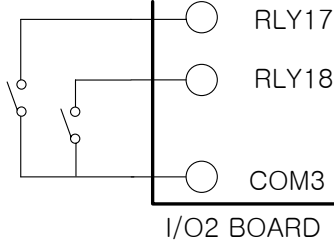
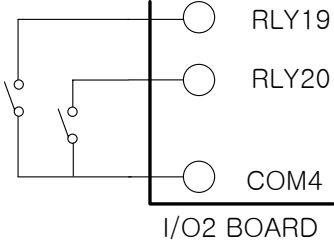
30V DC 5A Less, 250V AC 5A Less	30V DC 5A Less, 250V AC 5A Less	30V DC 5A Less, 250V AC 5A Less
 <p>RLY1 RLY2 COM1 I/O1 BOARD</p>	 <p>RLY3 RLY4 COM2 I/O1 BOARD</p>	 <p>RLY5 RLY6 COM3 I/O1 BOARD</p>
NO(Normal Open):30V DC 5A Less, 250V AC 5A Less NC(Normal Close):30V DC 1A Less, 250V AC 2A Less		NO(Normal Open):30V DC 5A Less, 250V AC 5A Less NC(Normal Close):30V DC 1A Less, 250V AC 2A Less
 <p>RLY7_NC RLY7_NO COM4 RLY8_NC RLY8_NO I/O1 BOARD</p>		 <p>RLY9_NC RLY9_NO COM5 RLY10_NC RLY10_NO P10 I/O1 BOARD</p>
30V DC 5A Less, 250V AC 5A Less		30V DC 5A Less, 250V AC 5A Less
 <p>RLY11 RLY12 RLY13 COM1 I/O2 BOARD</p>	 <p>RLY14 RLY15 RLY16 COM2 I/O2 BOARD</p>	
30V DC 5A Less, 250V AC 5A Less		30V DC 5A Less, 250V AC 5A Less
 <p>RLY17 RLY18 COM3 I/O2 BOARD</p>	 <p>RLY19 RLY20 COM4 I/O2 BOARD</p>	

1.4.2.8 External Contact Input : DI

	<p>CAUTION</p> <p>▶ Before starting external contact output : DI wiring, be sure to turn off the system, or else you will get an electrical shock.</p>
---	---

- ▶ For the external contact, use a no-voltage contact(including relay contact) that can operate appropriately under the terminal voltage for a close contact(approximate.. 5V) and the current for a opened contact(approximate.. 1mA).
- ▶ When using an open collector, select one with the 2V or less voltage for the closed contact, and 100μA or less leakage current for the open contact.

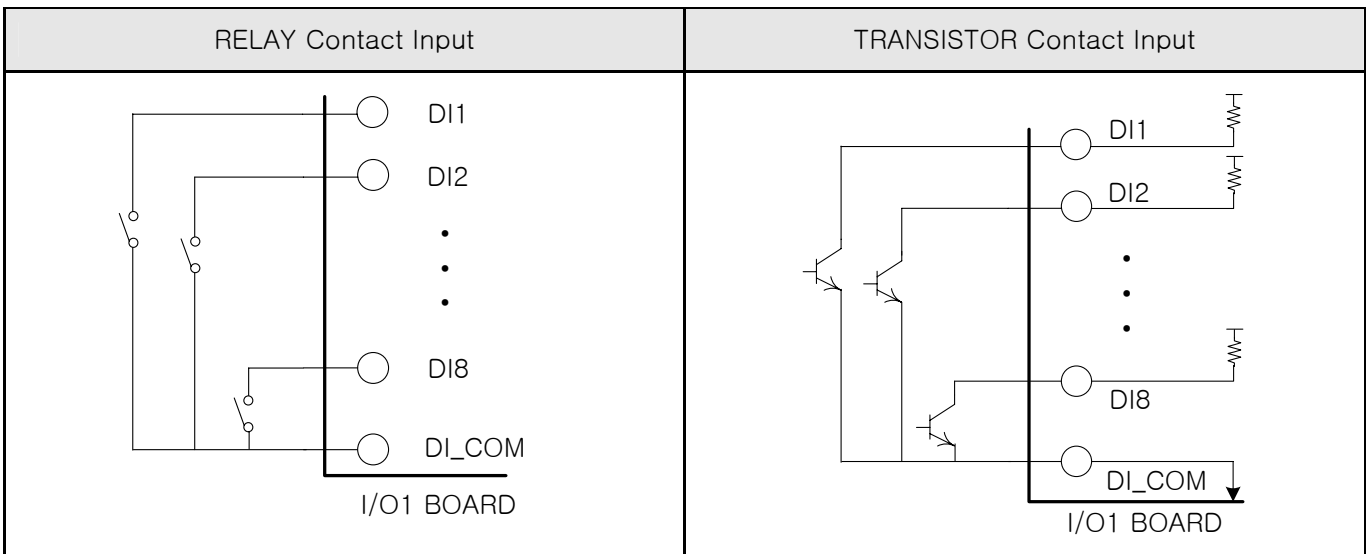

1.4.2.9 Auxiliary Relay

CAUTION  **CAUTION** ▶ If contact capacity is over 250V AC – resistance load 5A, 30V DC – resistance load 5A, use auxiliary relay for ON/OFF load.

▶ If you INDUCTANCE(L) load like as AUXILIARY RELAY or SOLENOIDE VALVE, It might make go to wrong or out of order relay, please make sure insert to parallel circuit with CR FILTER(AC) or DIODE(DC) by SURGE SUPPRESSOR of avoiding sparks.

- ▶ Recommend CR FILTER
- Sung Ho Electronics : BSE104R120 25V (0.1μ+120Ω)
 - HANA PARTS CO. : HN2EAC
 - Songmi Electric Co., Ltd. : CR UNIT 953, 955 etc
 - Jiwo Electric Co., Ltd. : SKV, SKVB etc
 - Shinyoung Communication Co., Ltd. : CR-CFS, CR-U etc

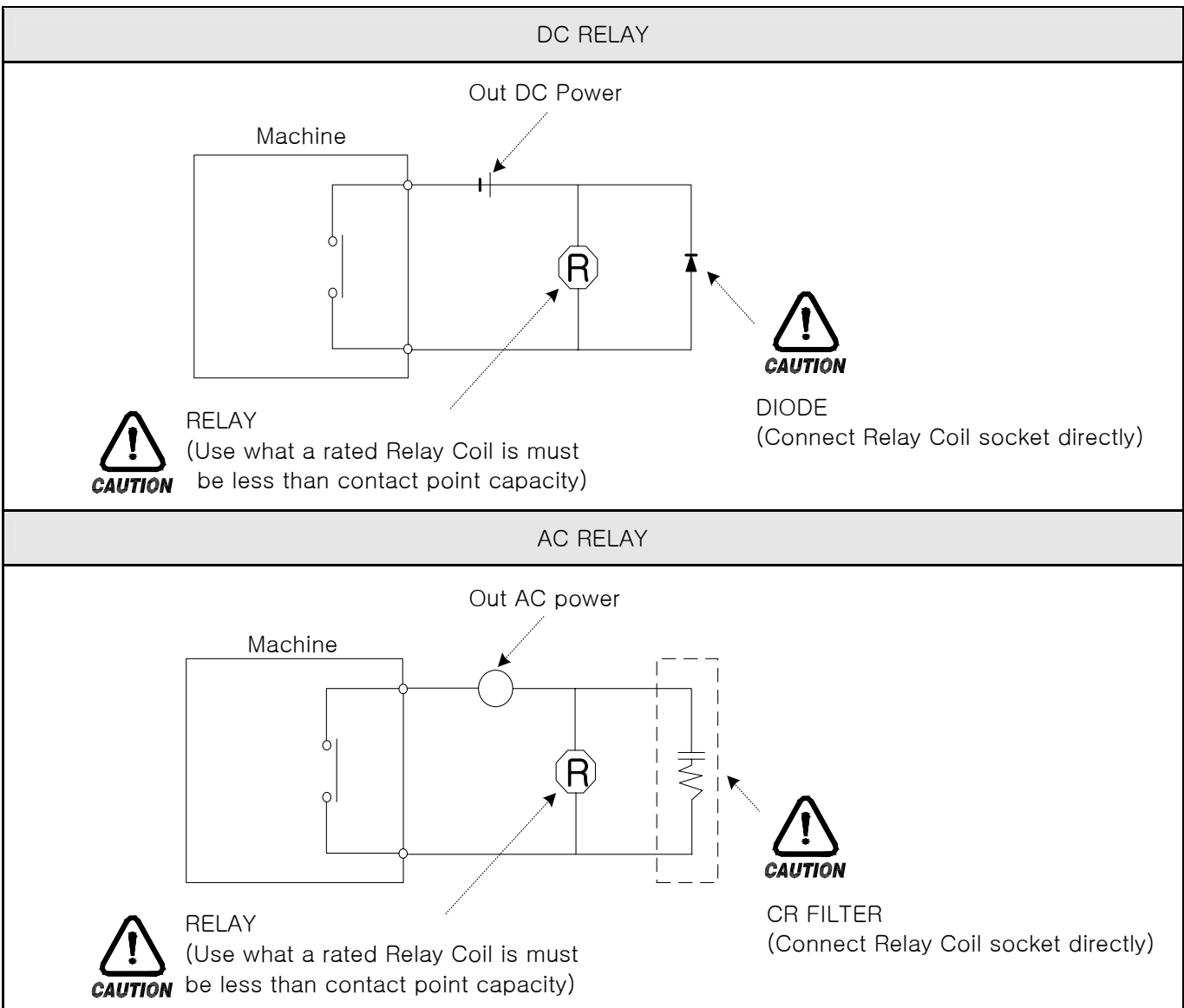

1.4.2.10 Communication(RS485/RS232C) Wiring



CAUTION ▶ Before starting communication wiring, be sure to turn off the system, or else you will get an electrical shock.

1.4.2.10.1 RS485 Wiring

- ▶ The slave side(TEMI880) can accommodate up to 99 units in a MULTIDROP connection.
- ▶ Be sure to connect a terminating resistance(220Ω 1/4W) to the units at the both.

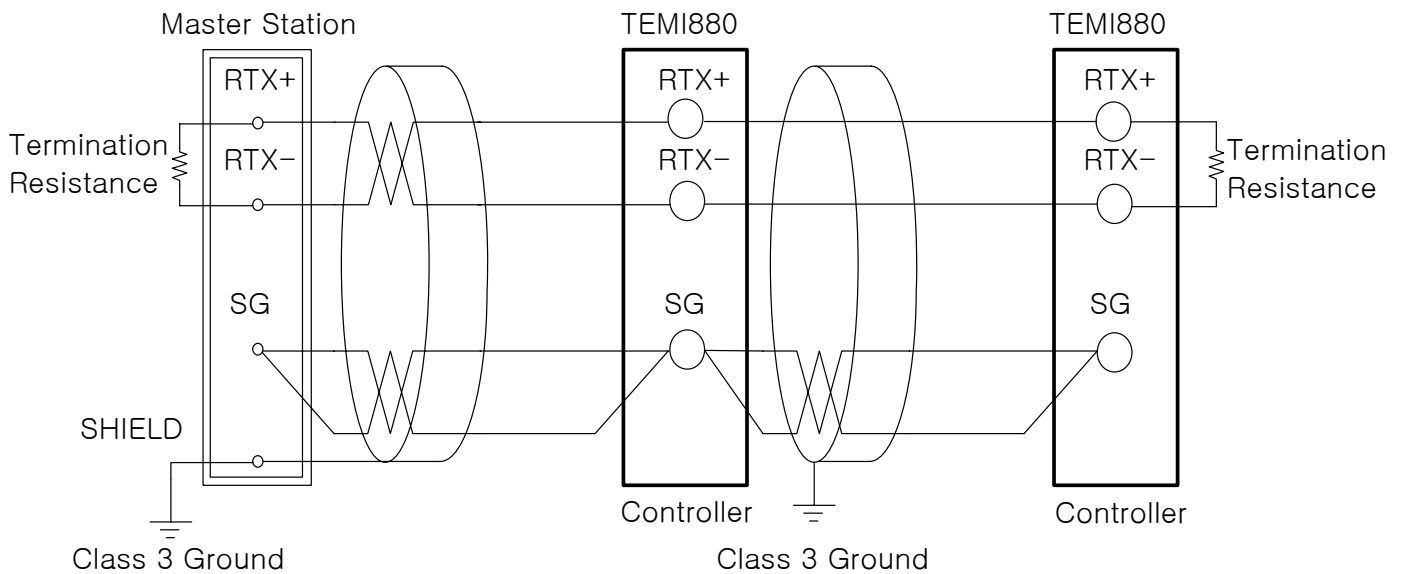

1.4.2.10.2 RS232C Wiring

- ▶ Connector : Wiring with 9 Pin

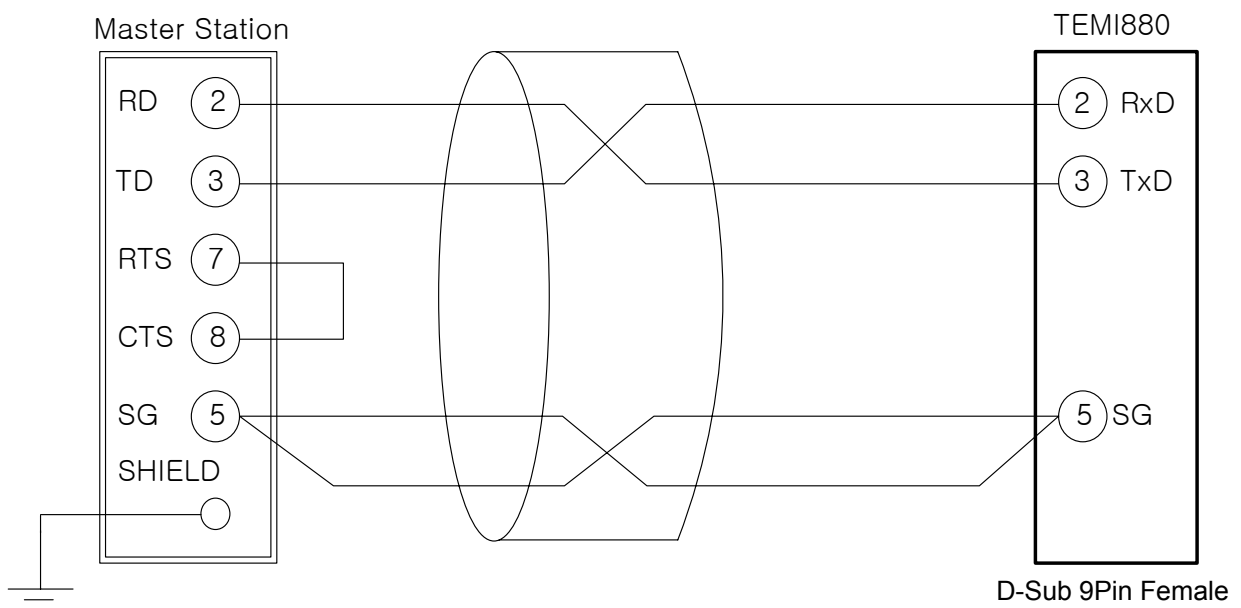

2. User Manual





2.1 Setup Button

- ▶ TEMI880 is easy to install & modify by touch screen as well as the map type menu. User enables to grasp the operation of control system with easy through graph on vivid LCD screen.

2.1.1 Initial setup button

- ▶ Display of the general setting button.

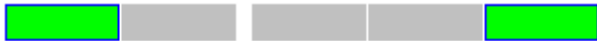
Table 1-1. General Setting Button

	Button		Function
1	Main		Change the page.
2	General execute button		It is used general execution or selection.
3	Page Up/ Down button		It is used page conversion on the same screen.
4	Setting value select button		It is used setting value selection.
5	Setting value input button		Convert to setting value input screen.
6	Setting value convert button		It is used setting value conversion.

2.1.2 Input setting value

- ▶ If user push setting value input button in the Table 1-1(General Setting Button), User can input data value.
- ▶ If user input data which is invalid, it makes 3 times buzzer, also there is “-LIMIT ERR” message on the setting value screen.

① Input key for the Digit setting

01 SEQ TEMP SP [-50.00 - 150.00]							
0	1	2	3	4	+/-	←	ESC
5	6	7	8	9	.	CLR	↵

② Input key for the Pattern & DI Error name setting

PT S NAME [ALPHA NUMERIC]							
, :- 0	QZ. 1	ABC 2	DEF 3	GHI 4	TOG	←	ESC
JKL 5	MNO 6	PRS 7	TUV 8	WXY 9	SP	CLR	↵

③ Input key for the Time Signal setting

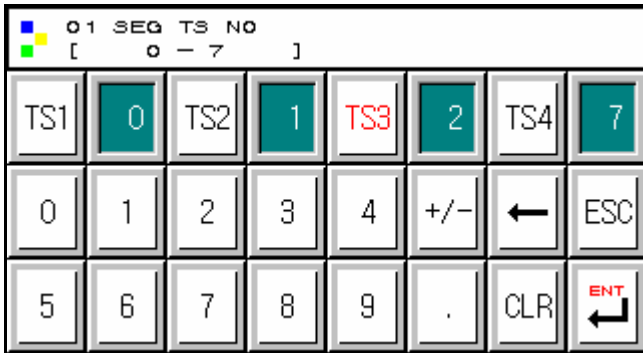

Touch Key Unlock

- ▶ If KEY LOCK is ON, Not input setting value. Therefore, Input setting value after KEY LOCK convert OFF.
- ☞ For more information, See [2.7 Operation Setting Screen](#).

2.1.3 Input error

- ▶ User can check a number of buzzer times.
- ☞ 1 time : Succeed set the data
- ☞ 3 times : Failed set the data



Using the touch screen

- ▶ Please do not use any pen/pencil, nail or any other sharp material. Otherwise, the touch screen might be broken or out of order.

2.2 Input Setting Value

- ▶ All of the Input value is setting by use setting value, pattern name and time signal input key.
- ▶ If user push setting value input button in the Table 1-1(General Setting Button), User can input data value.
- ▶ For the Time Signal input key, See [2.10.4 Time Signal Setting Screen.](#)
- ▶ For the Pattern Name input key, See [2.10.6 Pattern Name Setting Screen.](#)

2.2.1 Function of setting value input key

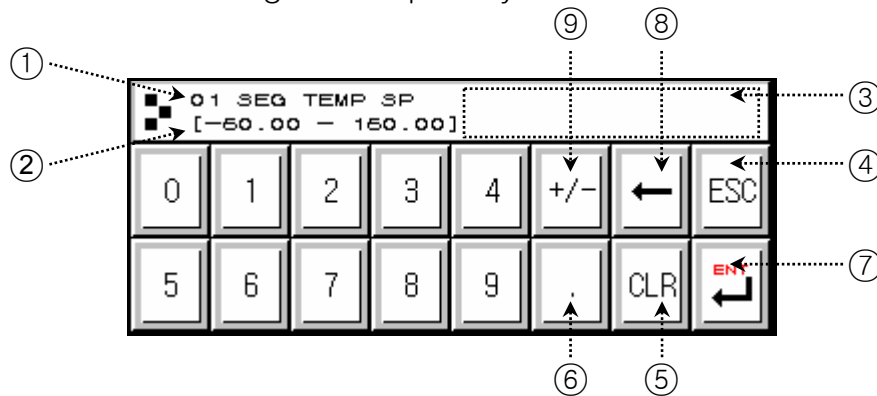

- ① Parameter.
- ② Valid data range.
- ③ -LIMIT ERR display when user input invalid setting value.
- ④ Cancel input setting value.
- ⑤ Clear input data.
- ⑥ Decimal point.
- ⑦ Save input data and go to main page.
- ⑧ Modify the input data, delete one by one.
- ⑨ Input sign(+ or -).

2.2.2 Parameter Setting

- ▶ Following figure show how to change setting value -50.00 to -12.57.
- Select setting value input button.
- Input the value(①→②→③→④→⑤→⑥) and ENT key(⑦).

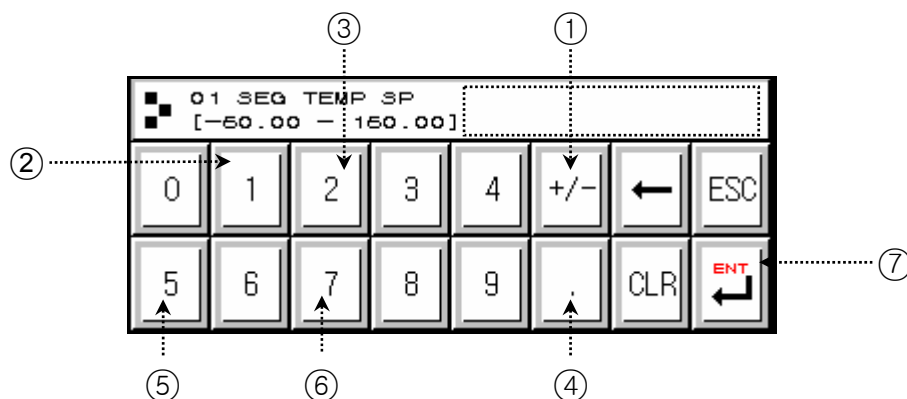

2.3 Block diagram of the basic processing

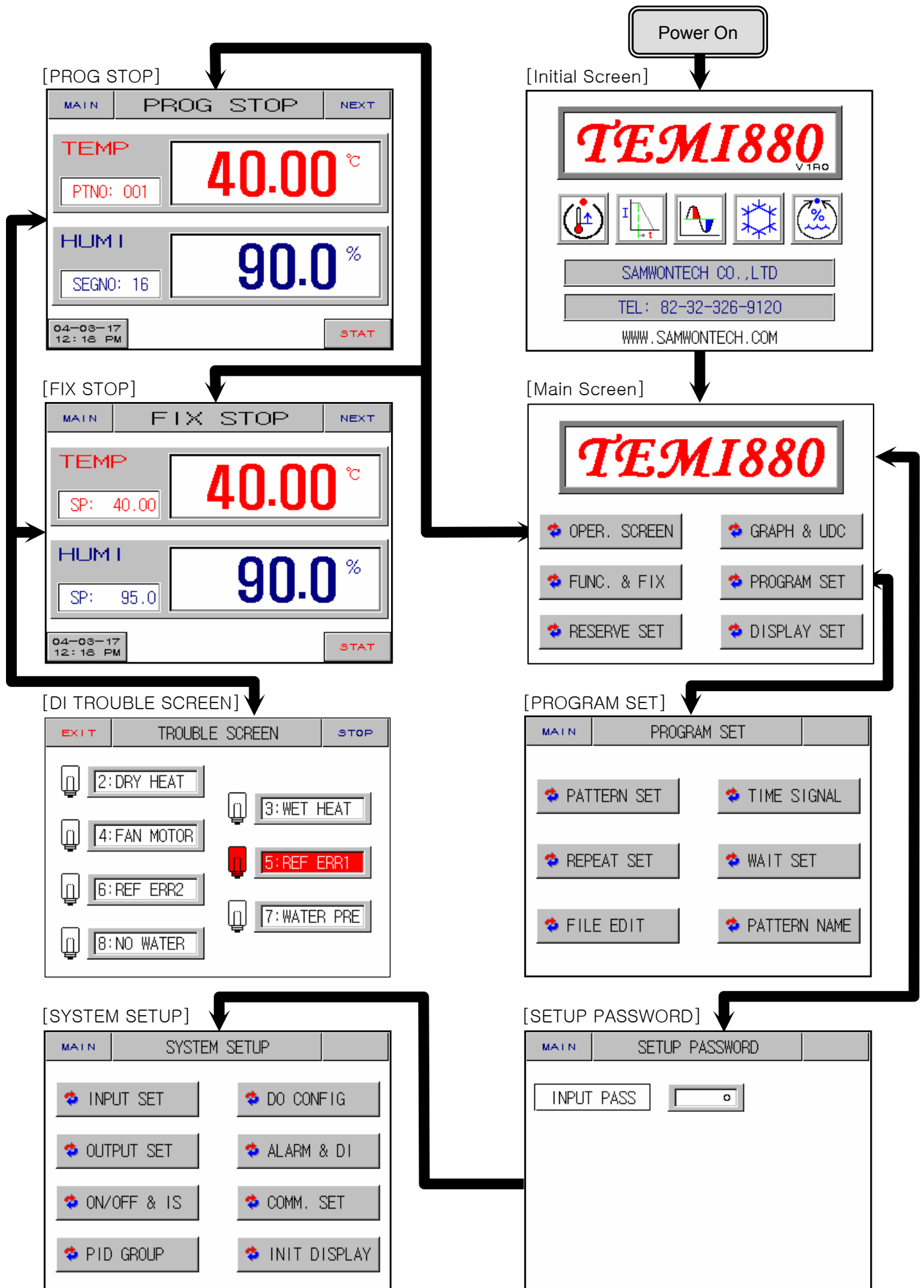

2.4 Initial Screen

- ▶ Initial Screen(the Beginning Power On).
- ▶ After 3 seconds, Transfer [2.6.1 Program Stop Screen](#) automatically.

Figure 2-1. Initial Screen

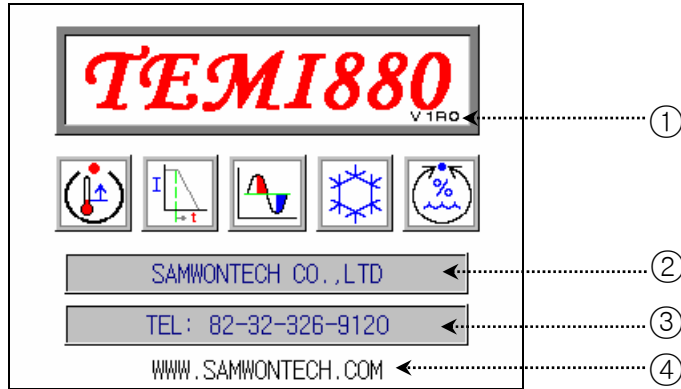

No.	Contents	Description	Additional Description
①	Version	Display present version information.	▶ V1R0 → VERSION 1, REVISION 0
②	Company	Display company name.	▶ Modify at 2.12.8 Initial Display Setting Screen .
③	Telephone	Display telephone number.	
④	Homepage	Display homepage address.	

2.5 Main Screen

► This screen is center of the total screen transfer.

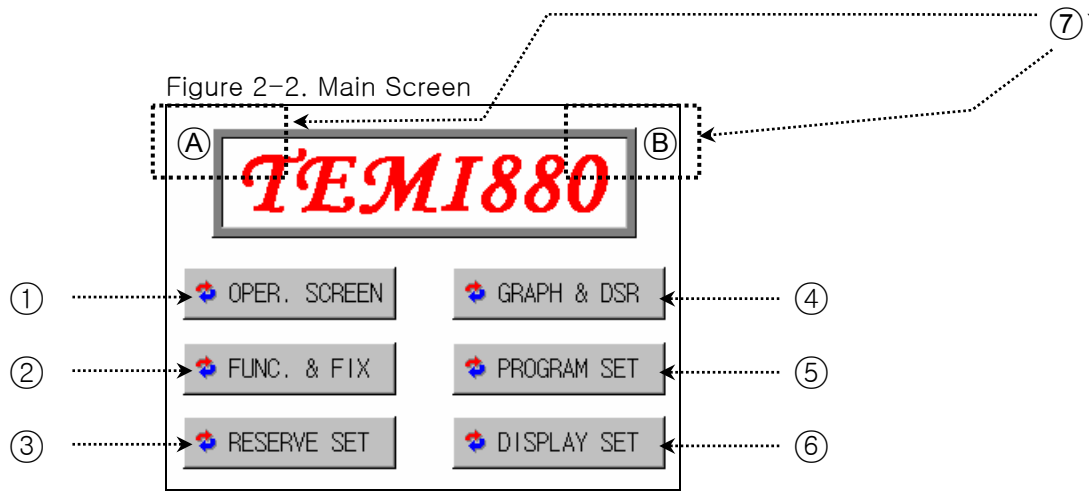

No.	Contents	Description	Additional Description
①	Operation Screen	Transfer operation screen.	► See 2.6 Operation Screen
②	Set Function	Transfer function and FIX setting screen.	► See 2.7 Operation Setting Screen
③	Set Reserve	Transfer reserve setting screen.	► See 2.8 Reserve Setting Screen
④	Display Graph	Transfer graph setting screen.	► See 2.9 Graph Setting Screen
⑤	Set Pattern	Transfer pattern setting screen.	► See 2.10 Pattern Setting Screen
⑥	Set Display	Transfer display setting screen.	► See 2.11 Display Setting Screen
⑦	HIDDEN KEY	Transfer inner system setting screen.	► Push (A) and (B), Display 2.13 Password Input Screen . ► See 2.12 System Setting Screen

2.6 Operation Screen

- ▶ At the running TEMI880, Display status and information.

2.6.1 Program Stop Screen

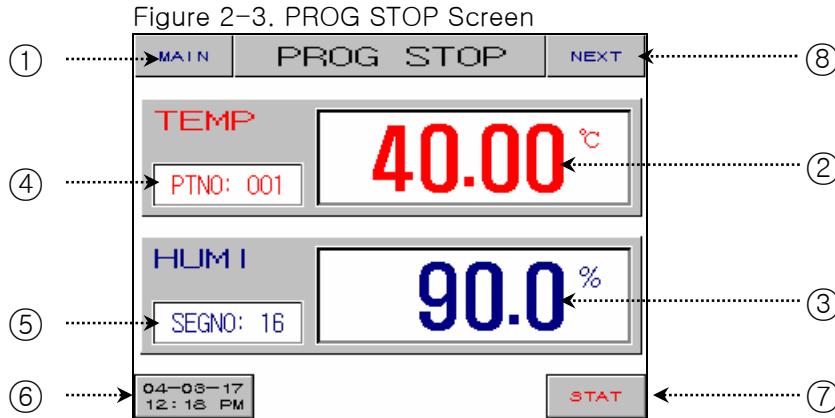

No.	Contents	Description	Additional Description
①	Main Button	Transfer to 2.5 Main Screen .	
②	Present Temp.	Display present temperature.	▶ Proper sensor type is in need of setting at 2.12.1 Input and Input Compensation Setting Screen .
③	Present Humi.	Display present humidity.	
④	Pattern No.	Display running pattern number.	▶ Push button and set pattern number for operating.
⑤	Segment	Display programmed segment count of the present pattern.	▶ Program pattern input at 2.10.1 Edit Pattern Screen .
⑥	Time Button	Display present time. Time button is pushed, turn off LCD screen. Even if turn off the light automatically, controller still working and turn on the light if user touch any point.	▶ Automatic turn off setting time at 2.7 Operation Setting Screen . ☞ Backlight time is setting 10 minutes. ▶ Present time is setting at 2.8 Reserve Setting Screen .
⑦	Start Button	Display confirmable box for program running.	▶ See (Figure2-4).
⑧	Next Button	Transfer at Figure 2-9	



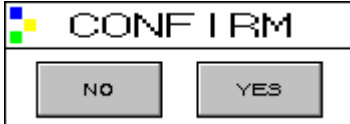

Confirmable Box

☞ At this CONFIRM window, you can confirm if you really want doing job or not.

예) PROG(or FIX) STOP ↔ PROG(or FIX) RUN
HOLD, STEP, TUNING OFF ↔ HOLD, STEP, TUNING ON
pattern copy, pattern delete etc.

Figure 2-4. PROG STOP – Confirm

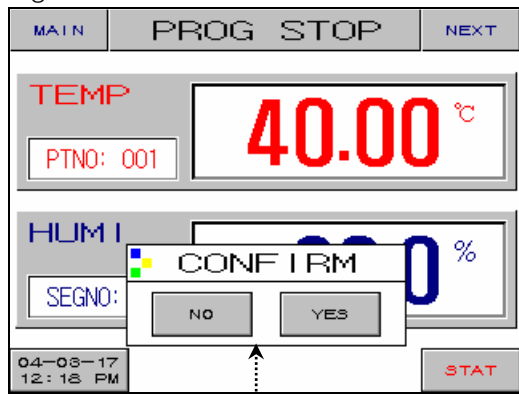

①

Figure 2-5. PROG STOP – Pattern End

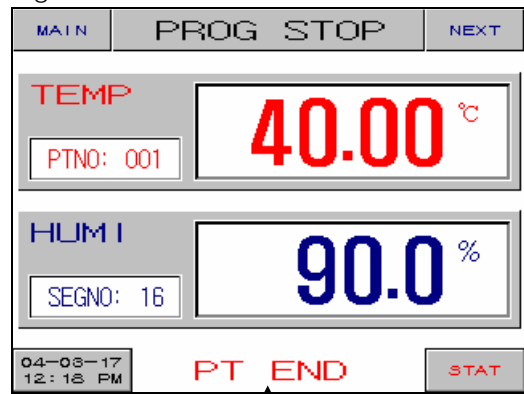

②

Figure 2-6. PROG STOP – Reserved

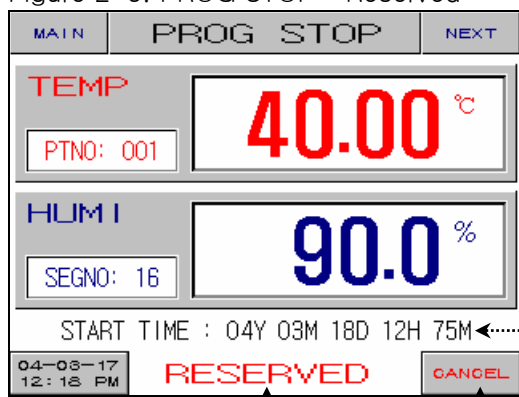

④

⑤

③

No.	Contents	Description	Additional Description
①	Confirmable Box	Program run or not.	<ul style="list-style-type: none"> ▶ Clicked YES button : Program Start ▶ Clicked NO button : Transfer at Figure 2-3.
②	Pattern End	Blinking at the end of setting program.	<ul style="list-style-type: none"> ▶ if user touch any point, PT END disappear. ☞ If Pattern End message is disappeared, Relay status transfer into OFF.
③	Start Time	Display start time at setting reservation.	
④	Reservation	Blinking at setting reservation.	<ul style="list-style-type: none"> ▶ Setting of the pattern number.
⑤	Cancel Button	Cancel button of the reservation.	<ul style="list-style-type: none"> ▶ Clicked Cancel button : Transfer at Figure 2-3.

2.6.2 Program Run Screen

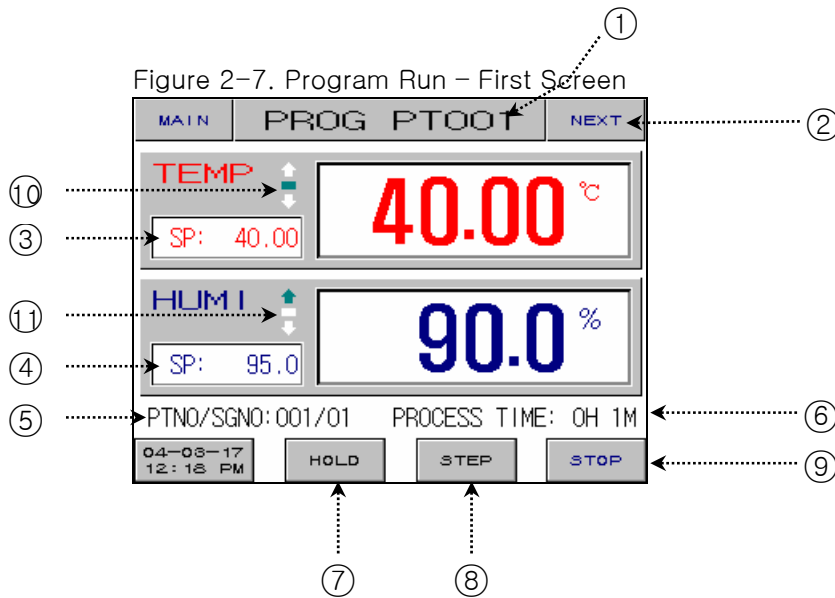

No.	Contents	Description	Additional Description
①	Pattern Name	Display pattern name of the present running.	▶ See 2.10.6 Pattern Name Setting Screen
②	Next Button	Transfer at Figure 2-8.	
③	Temp. SP Value	Display present Temp. SP(Set Point).	
④	Humi. SP Value	Display present Humi. SP(Set Point).	
⑤	Pattern/Segment	Display pattern and segment number.	
⑥	Running Time	Display total running time.	
⑦	Hold Button	Hold on or off.	▶ Hold button's color transferred to red at HOLD ON.
⑧	Step Button	Present segment stop running, Move next segment.	
⑨	Stop Button	Display confirmable box.	
⑩	Temp. Status Display Lamp	Display present Temp. status.	▶ See 2.12.5 DO CONFIG Setting Screen
⑪	Humi. Status Display Lamp	Display present Humi. status.	

Figure 2-8. Program Run – Second Screen

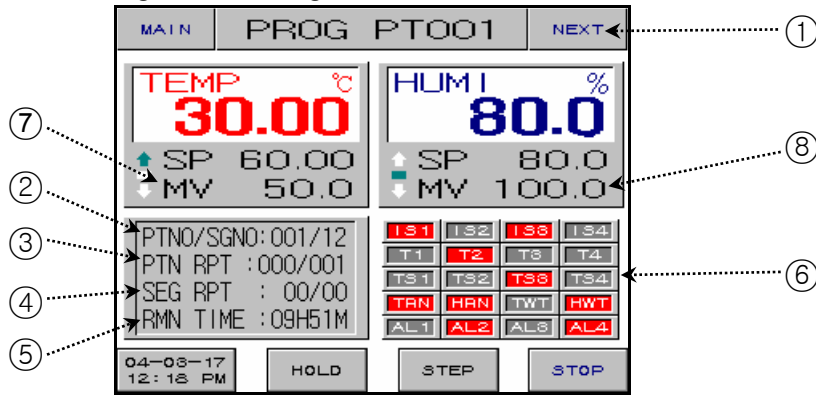

No.	Contents	Description	Additional Description
①	Next Button	Transfer at Figure 2-9.	▶ Only using at TEMI880.
②	Running Pattern	Display program pattern and segment number.	
③	Pattern Repeat	Display pattern repeat status. repeated count / total repeat count	▶ See 2.10.2 Repeat Setting Screen
④	Segment Repeat	Display segment repeat status. repeated count / total repeat count	
⑤	Remain Time	Display remain time of the present running segment.	
⑥	Status Display Lamp	ON status : Red. OFF status : Gray.	▶ See 2.12.8 Initial Display and Status Display Lamp Setting Screen ☞ Total 20 lamp display.
⑦	Temp. MVOUT	Display Temp. MVOUT.	
⑧	Humi. MVOUT	Display Humi. MVOUT.	

▶ Figure2-9 is used at TEMI880.

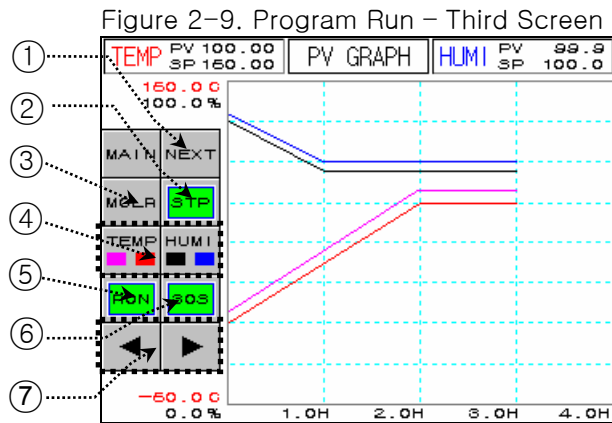

No.	Contents	Description	Additional Description
①	Next Button	Transfer at Figure 2-7.	
②	STP/RPT Button	Select graph display status.	<ul style="list-style-type: none"> ▶ STP : In case sampling time is 60 seconds, data is stored during 8 days and data storage is stopped. ▶ RPT : In case sampling time is 60 seconds, data display 8 days recently and data storage is repeatedly.
③	MCLR Button	Delete graph display data.	
④	Select Graph	Select Temp.(SP, PV) or Humi.(SP, PV) graph.	<ul style="list-style-type: none"> ▶ Temp. PV : Display magenta. ▶ Temp. SP : Display red. ▶ Humi. PV : Display blue. ▶ Humi. SP : Display black.
⑤	RON/ROF Button	Select graph storage or not.	<ul style="list-style-type: none"> ▶ RON : PV graph storage ON. ▶ ROF : PV graph storage OFF.
⑥	30S/60S Button	Select sampling time.	<ul style="list-style-type: none"> ▶ 30S : 30 seconds. ▶ 60S : 60 seconds.
⑦	Previous/Next Button	Move previous/next page.	

2.6.3 Fix Stop Screen

Figure 2-10. Fix Stop Screen

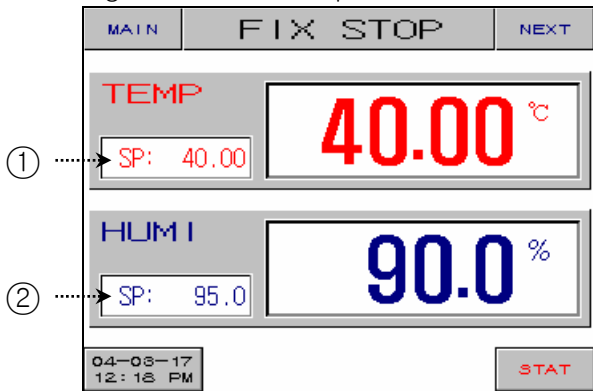

Figure 2-11. Fix Stop - Confirm

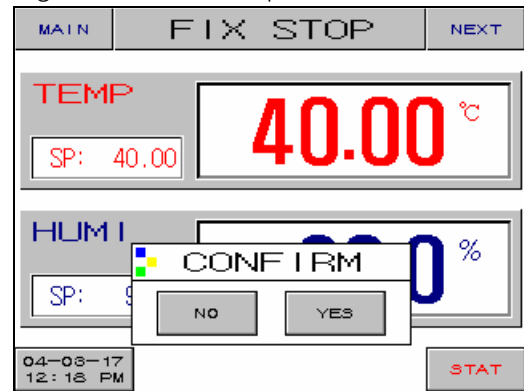
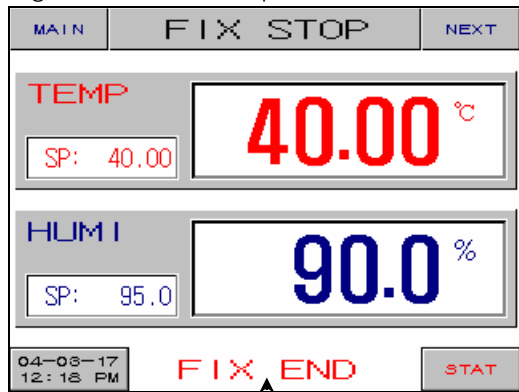
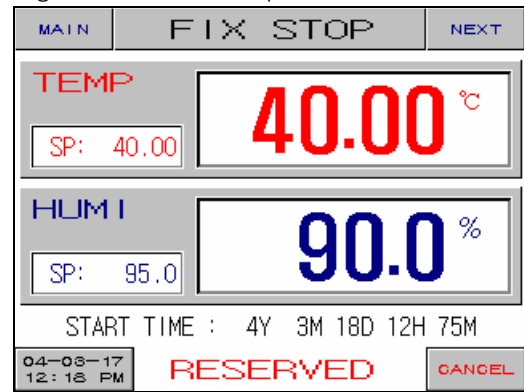

Figure 2-12. Fix Stop - Time End



③

Figure 2-13. Fix Stop - Reserved



No.	Contents	Description	Additional Description
①	Temp. SP Value	Display present Temp. SP (Set Point).	▶ See 2.2 Input Setting Value Input SP(Set Point) .
②	Humi. SP Value	Display present Humi. SP (Set Point).	
③	Fix Run Stop	Blinking at Fix Stop.	▶ See 2.7 Operation Setting Screen ▶ if user touch any point, FIX END disappear.

2.6.4 Fix Run Screen

Figure 2-14. Fix Run – First Screen

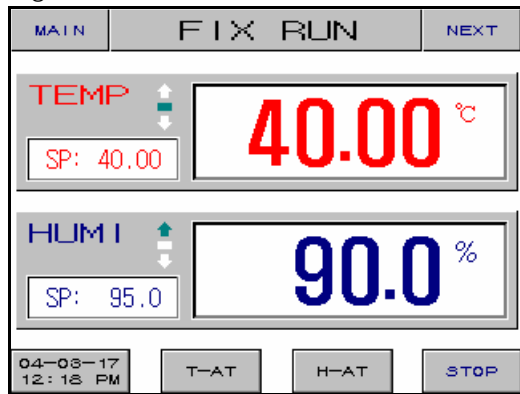

①

②

③

Figure 2-15. Fix Run – Second Screen

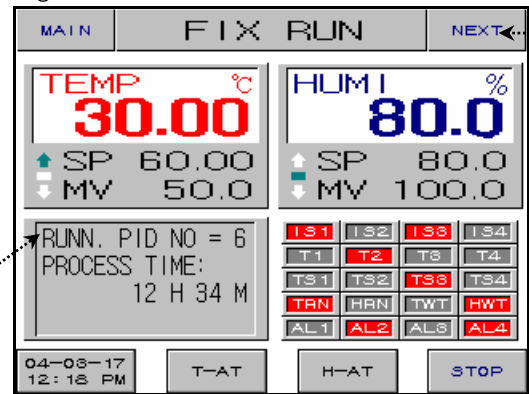

④

No.	Contents	Description	Additional Description
①	Temp. Tuning	Temp. side : Auto Tuning On/Off.	▶ T-AT button's color transferred to red at Auto Tuning of the Temp. side.
②	Humi. Tuning	Humi. side : Auto Tuning On/Off.	▶ H-AT button's color transferred to red at Auto Tuning of the Humi. side.
③	PID Group No.	Display PID Group No.	▶ See 2.12.4 PID Setting Screen
④	Next Button	Transfer at Figure 2-9.	

2.7 Operation Setting Screen

► This is the screen about additional function of the general machine and additional setting at Fix Run.

Figure 2-16. Operation Setting – First Screen

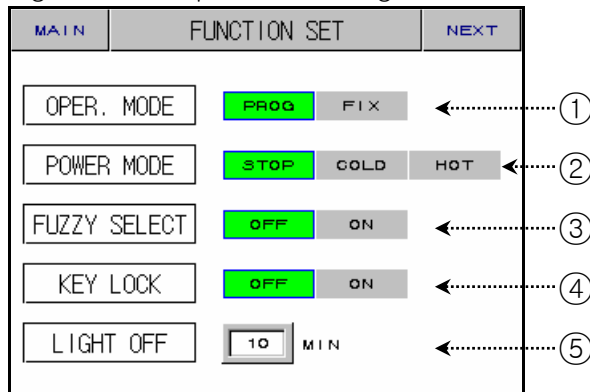
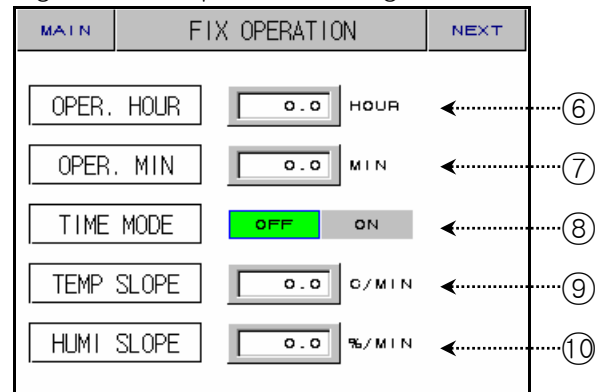

Figure 2-17. Operation Setting – Second Screen



No.	Contents	Description	Additional Description																
①	Operation Mode	Select Program mode or Fix mode.	<ul style="list-style-type: none"> ► PROG : 2.6.1 Program Stop Screen ► FIX : 2.6.3 Fix Stop Screen ☞ It isn't changed at the running. 																
②	Power Mode	Setup when re-start after power off. <ul style="list-style-type: none"> ► Recognize to power off if it is more than 3 seconds. ► If re-start before 3 seconds, It will run to Hot mode Automatically. 	<ul style="list-style-type: none"> ► The running after power on <table border="1"> <thead> <tr> <th>Before Power Off</th> <th>PROG/FIX STOP</th> <th>PROG RUN</th> <th>FIX RUN</th> </tr> </thead> <tbody> <tr> <td>STOP</td> <td>PROG/FIX STOP</td> <td>PROG STOP</td> <td>FIX STOP</td> </tr> <tr> <td>COLD</td> <td>PROG/FIX STOP</td> <td>Run from first segment.</td> <td>FIX RUN</td> </tr> <tr> <td>HOT</td> <td>PROG/FIX STOP</td> <td>Run from running segment time before power off.</td> <td>FIX RUN</td> </tr> </tbody> </table>	Before Power Off	PROG/FIX STOP	PROG RUN	FIX RUN	STOP	PROG/FIX STOP	PROG STOP	FIX STOP	COLD	PROG/FIX STOP	Run from first segment.	FIX RUN	HOT	PROG/FIX STOP	Run from running segment time before power off.	FIX RUN
			Before Power Off	PROG/FIX STOP	PROG RUN	FIX RUN													
			STOP	PROG/FIX STOP	PROG STOP	FIX STOP													
			COLD	PROG/FIX STOP	Run from first segment.	FIX RUN													
HOT	PROG/FIX STOP	Run from running segment time before power off.	FIX RUN																
③	Fuzzy Select	Control over shoot by fuzzy select.																	
④	Key Lock	Key Lock/Unlock.																	
⑤	Light Off	Set time of the backlight.	► Backlight time is setting 10 minutes.																
⑥	Operation Hour(H)	Set Hour.																	
⑦	Operation Minute(M)	Set Minute.																	
⑧	Time Mode	Set Time Mode On/Off.	<ul style="list-style-type: none"> ► OFF : Fix running is stopped at the STOP button clicked. ► ON : It is stop after running time (set ⑥, ⑦) automatically. 																
⑨	Temp. Slope	Temp. up/down slope.	► Temp./Humi. value goes to the SP gradually. It is applied both of up and down.																
⑩	Humi. Slope	Humi. up/down slope.																	



FUZZY Operation

- ▶ When you have a heavy load variation or frequently change sp in operation, usually it causes overshoot, in this case you can control overshoot with fuzzy function effectively.
- ▶ Internal operation order of fuzzy function
 - ① When PV closes SP, SUPER SP operates calculation.
 - ② MV is calculated the value(SP) of calculation.
- 👁️ **suppressing overshoot.**

▶ PV change depends on Fuzzy Operation

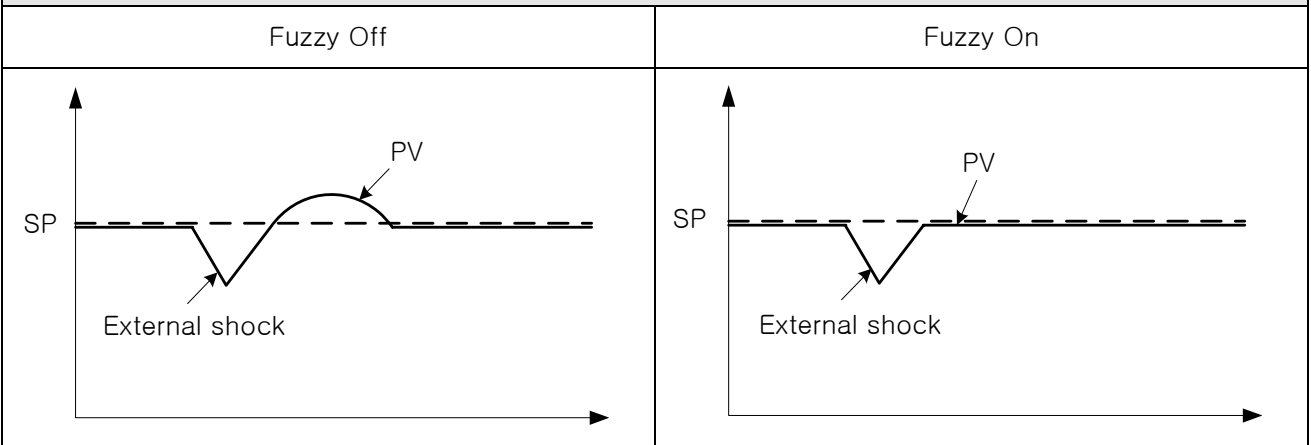

SLOPE Operation

- ▶ A case where TSP is changed, SP value is changed gradually from present PV to TSP.

▶ SLOPE Operation

- ▶ OPER. MODE
→ FIX RUN
- ▶ TEMP SLOPE
→ 20.0 °C/MIN

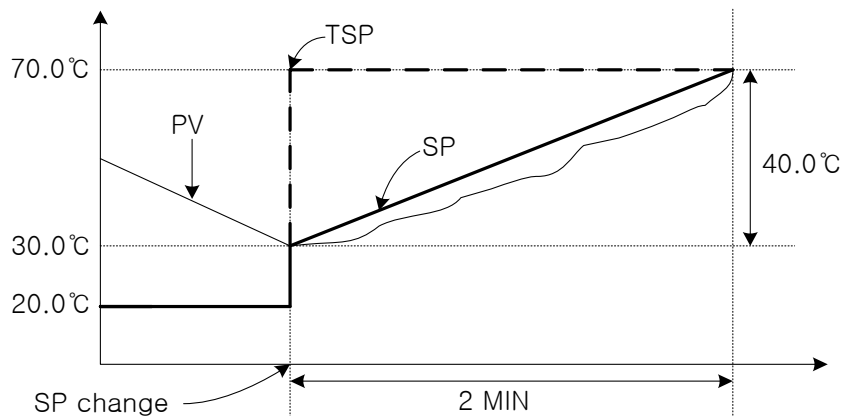

[changed SP(TSP) - PV at SP change] : 20.0°C slope / 1 minute.
 → (70.0 - 30.0) °C = 40.0°C : 20.0°C slope / 1 minute.

👁️ **SP value is changed from 30.0°C to 70.0°C gradually per 2 minutes.**

2.8 Reserve Setting Screen

► This is the screen about time and reserved operation setting.

Figure 2-18. Reserve Setting Screen

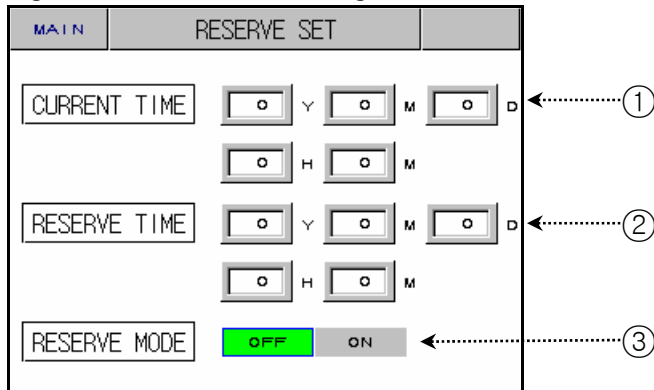

No.	Contents	Description	Additional Description
①	Current Time	Set and display present date & time.	
②	Reserve Time	Set and display reservation date & time.	
③	Reserve Mode	Select Reservation On or Off.	► See Figure 2-6, Figure 2-13

2.9 Graph Setting Screen

► This is screen display graph for the input pattern at 2.10.1 Edit Pattern Screen.

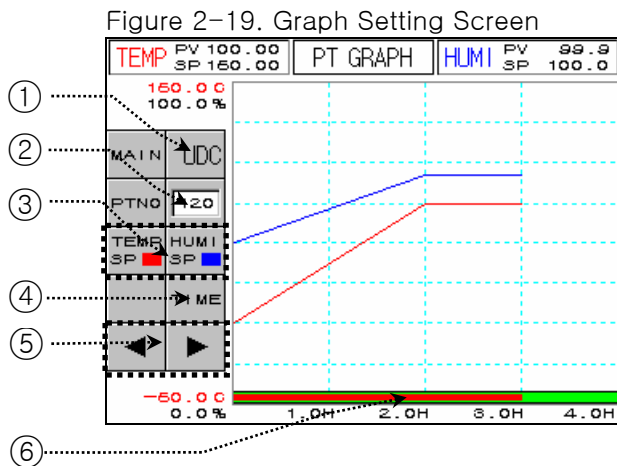

No.	Contents	Description	Additional Description
①	UDC Button	Move UDC Setting page.	► At a using UDC option.
②	Pattern No.	Set pattern number.	
③	Select Graph	Select Temp. SP or Humi. SP graph.	► Temp. SP : Display red. ► Humi. SP : Display black.
④	Time Button	Change time scale.	► Push time button => change time scale. 0H 1H 2H 3H 4H ↓ 0H 3H 6H 9H 12H ↓ 0H 6H 12H 18H 24H ↓ 0H 12H 24H 36H 48H ↓ 0H 24H 48H 72H 96H
⑤	Previous/Next Button	Move previous/next page.	
⑥	Time Graph	Display processed time.	► Display processed time with red color.

- ▶ Set graph storage(UDC100 : Data Storage Recorder).
- ☞ Graph storage function is possible that you purchase UDC100.

Figure 2-20. Graph Storage Setting Screen

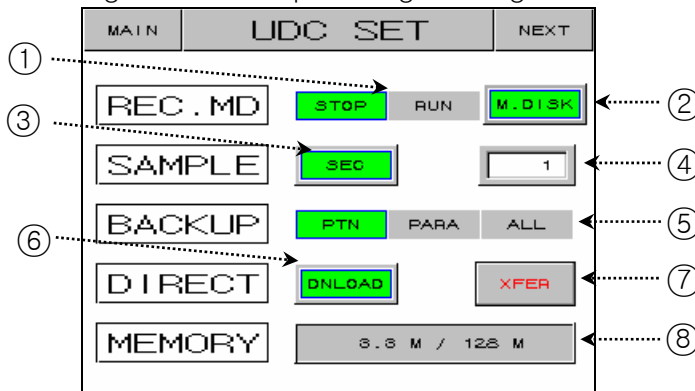

No.	Contents	Description	Additional Description
①	Operation Mode	Data storage run or not.	<ul style="list-style-type: none"> ▶ You can “RUN” operation when program or fix running. ▶ It is changed “STOP” when program or fix ending.
②	Save Location	Select save location	<ul style="list-style-type: none"> ▶ M.DISK : Save in UDC300 ▶ U.DISK : Save in USB
③	Time Unit	Select time unit.	
④	Sampling Time	Set sampling time.	
⑤	BACKUP	Select file.	<ul style="list-style-type: none"> ▶ PTN : Select parameter about the pattern setting, repeat setting and pattern name setting. ▶ PARA : Select all parameter except the selected parameter in the “PTN” and communication setting parameter. ▶ ALL : Select all parameter except the communication setting parameter.
⑥	Upload/Download/MD.DMP/MD.CLR	Select upload or download or memory dump or memory clear.	<ul style="list-style-type: none"> ▶ UPLOAD : Uploading selected file from USB connected at UDC300. ▶ DNLOAD : Downloading selected file to USB connected at UDC300. ▶ MR.DMP : Copy to USB data which saved at memory of UDC300. ▶ MR.CLR : Clear memory of UDC300.
⑦	XFER	Execute button.	<ul style="list-style-type: none"> ▶ You can't move screen during upload or download. ▶ It is possible Upload/Download transmission only in PROG/FIX STOP state.
⑧	MEMORY	Used memory / Total memory.	

2.10 Pattern Setting Screen

► This is the screen about pattern setting.

Figure 2-21. Pattern Setting Screen

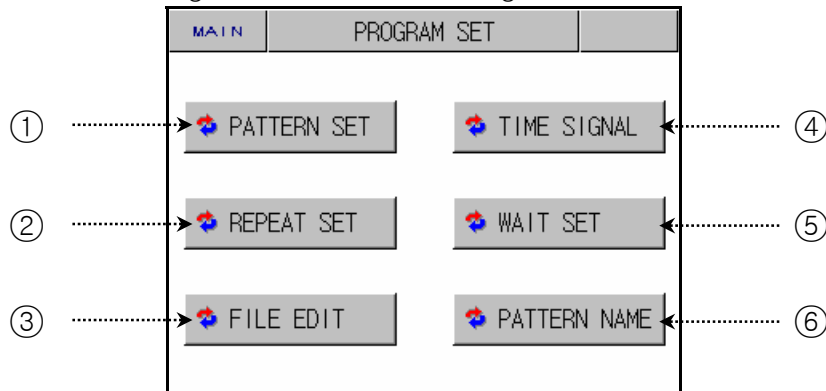

No.	Contents	Description	Additional Description
①	Set Pattern	Move edit pattern screen.	► See 2.10.1 Edit Pattern Screen
②	Set Repeat	Move repeat setting screen.	► See 2.10.2 Repeat Setting Screen
③	Edit File	Move edit file screen.	► See 2.10.3 Edit File Screen
④	Time Signal	Move time signal setting screen.	► See 2.10.4 Time Signal Setting Screen
⑤	Set Wait	Move wait operation setting screen.	► See 2.10.5 Wait Operation Setting Screen
⑥	Pattern Name	Move pattern name setting screen.	► See 2.10.6 Pattern Name Setting Screen

2.10.1 Edit Pattern Screen

Figure 2-22. Edit Pattern Screen

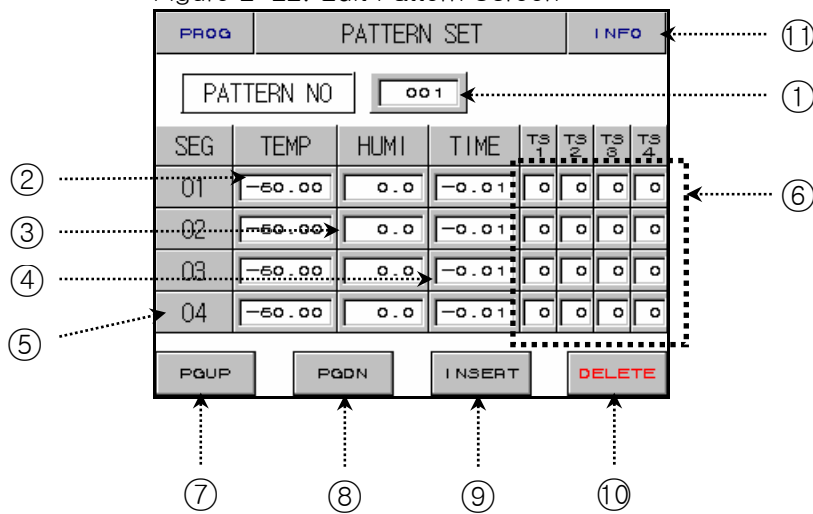

No.	Contents	Description	Additional Description										
①	Pattern No.	Set pattern number.	▶ Change pattern number of 2.10.2 Repeat Setting Screen .										
②	Segment Temp.	Set segment temperature.											
③	Segment Humi.	Set segment humidity.											
④	Segment Time	Set segment time.	▶ Input method of the time. <table border="1"> <thead> <tr> <th>Set Time</th> <th>Display</th> </tr> </thead> <tbody> <tr> <td>OFF</td> <td>-0.01</td> </tr> <tr> <td>1 minute</td> <td>0.01</td> </tr> <tr> <td>30 minutes</td> <td>0.30</td> </tr> <tr> <td>1 hour</td> <td>1.00</td> </tr> </tbody> </table>	Set Time	Display	OFF	-0.01	1 minute	0.01	30 minutes	0.30	1 hour	1.00
Set Time	Display												
OFF	-0.01												
1 minute	0.01												
30 minutes	0.30												
1 hour	1.00												
⑤	Segment No.	A case where insert or delete segment, Clicked this button.	▶ Segment color is displayed red at the button clicked. In this case, you can segment insert or delete.										
⑥	Time Signal	Set time signal.	▶ See 2.10.1.4 Set Method of the Time Signal ▶ See 2.10.4 Time Signal Setting Screen										
⑦	Next Button	Move next page.	▶ See 2.10.1.3 Move Screen										
⑧	Previous Button	Move previous page.											
⑨	Insert Segment	Insert segment.	▶ See 2.10.1.1 Insert Method of the Segment										
⑩	Delete Segment	Delete segment.	▶ See 2.10.1.2 Delete Method of the Segment										
⑪	Info. Button	Move file information screen.	▶ See 2.10.1.5 File Information Screen										

2.10.1.1 Insert Method of the Segment

▶ Example => Insert segment.

Figure 2-23. Before Insert Segment

SEG	TEMP	HUMI	TIME	T ^S ₁	T ^S ₂	T ^S ₃	T ^S ₄
01	50.00	90.0	8.00	00	00	00	00
02	40.00	90.0	8.00	01	04	05	06
03	-50.00	0.0	-0.00	00	00	00	00
04	-50.00	0.0	-0.01	00	00	00	00

Figure 2-24. After Insert Segment

SEG	TEMP	HUMI	TIME	T ^S ₁	T ^S ₂	T ^S ₃	T ^S ₄
01	50.00	90.0	8.00	00	00	00	00
02	40.00	90.0	8.00	01	04	05	06
03	40.00	90.0	8.00	01	04	05	06
04	-50.00	0.0	-0.01	00	00	00	00

- 1) Clicked dot-rectangle areas of Figure 2-23, “02” character color is changed red.
Clicked insert button(⑨) of Figure 2-22. Edit Pattern Screen, a segment of the same value is inserted.

2.10.1.2 Delete Method of the Segment

▶ Example => Delete segment.

Figure 2-25. Before Delete Segment

SEG	TEMP	HUMI	TIME	T ^S ₁	T ^S ₂	T ^S ₃	T ^S ₄
01	50.00	90.0	8.00	00	00	00	00
02	40.00	90.0	8.00	01	04	05	06
03	60.00	80.0	0.30	02	00	00	00
04	-50.00	0.0	-0.01	00	00	00	00

Figure 2-26. After Delete Segment

SEG	TEMP	HUMI	TIME	T ^S ₁	T ^S ₂	T ^S ₃	T ^S ₄
01	50.00	90.0	8.00	00	00	00	00
02	60.00	80.0	0.30	02	00	00	00
03	-50.00	0.0	-0.01	00	00	00	00
04	-50.00	0.0	-0.01	00	00	00	00

- 1) Clicked dot-rectangle areas of Figure 2-25, “02” character color is changed red.
- 2) Clicked delete button(⑩) of Figure 2-22. Edit Pattern Screen, “02” segment is deleted.

 **a case where segment do not insert or delete.**

NOTE

- ☞ If segment setting value is equaled Initial value, you are not able to insert or delete.
- ☞ You are not able to insert or delete at the running.

2.10.1.3 Move Screen

⑧ button of Figure 2-22. Edit Pattern Screen

SEG	TEMP	HUMI	TIME	T ^S ₁	T ^S ₂	T ^S ₃	T ^S ₄
01	50.00	90.0	8.00	00	00	00	00
02	60.00	80.0	0.30	02	00	00	00
03	-50.00	0.0	-0.01	00	00	00	00
04	-50.00	0.0	-0.01	00	00	00	00

SEG	TEMP	HUMI	TIME	T ^S ₁	T ^S ₂	T ^S ₃	T ^S ₄
05	45.00	95.0	0.30	00	03	00	00
06	45.00	95.0	0.40	02	00	00	00
07	10.00	55.0	0.30	00	02	00	00
08	-50.00	0.0	-0.01	00	00	00	00

⑦ button of Figure 2-22. Edit Pattern Screen

2.10.1.4 Set Method of the Time Signal

► This is the screen about time signal setting. (TS2 : TYPE “1”, TS3 : TYPE “2”, TS4 : TYPE “7”)

Figure 2-27. Before Time Signal Setting

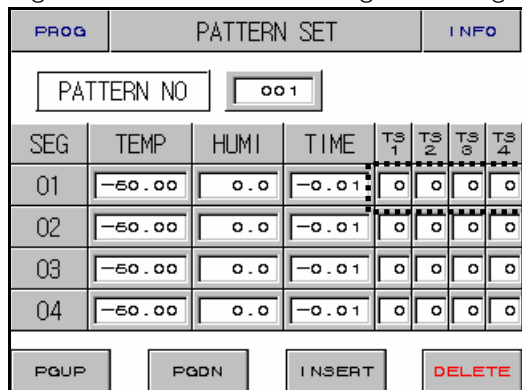
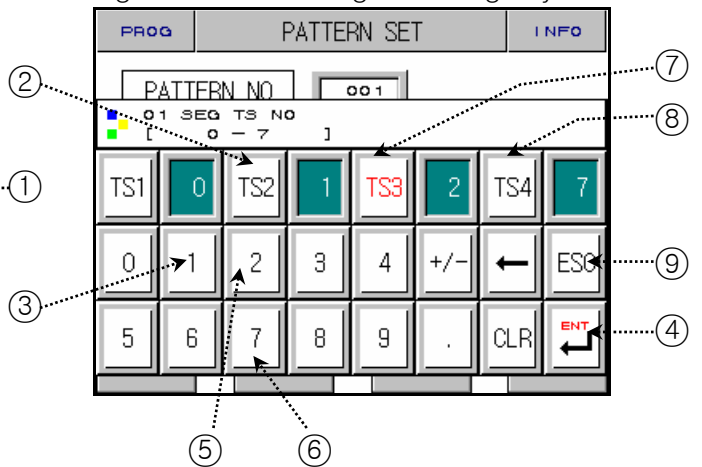

Figure 2-28. Time Signal Setting Key



- 1) Clicked dot-rectangle areas(①) of Figure 2-27. Before Time Signal Setting, Display Figure 2-28. Time Signal Setting Key.
- 2) The order of the time signal setting : ②→③→④→⑦→⑤→④→⑧→⑥→④→⑨

☞ A kind of the input time signal : See 2.10.4 Time Signal Setting Screen.

2.10.1.5 File Information Screen

► Display number of the used pattern and segment.

Figure 2-29. File Information Screen

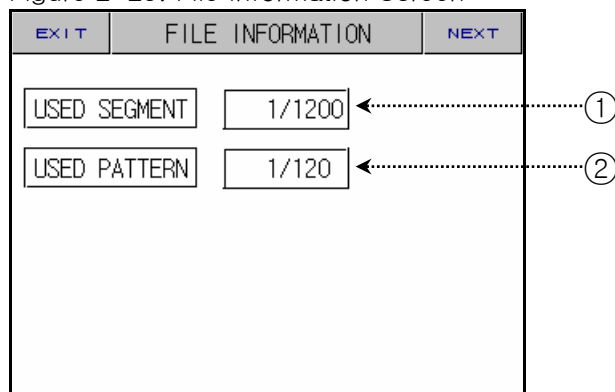

No.	Contents	Description	Additional Description
①	Used Segment	Display used segment number.	► Used segment number / Total segment number
②	Used Pattern	Display used pattern number.	► Used pattern number / Total pattern number

2.10.2 Repeat Setting Screen

Figure 2-30. Repeat Setting Screen

The screenshot shows a 'REPEAT SET' screen with the following fields and callouts:

- ①: PTN NO (value: 1)
- ②: PTN RPT (value: 1)
- ③: LINK PTN (value: 0)
- ④: TITLE: PROG PT001
- ⑤: START (value: 0)
- ⑥: END (value: 0)
- ⑦: COUNT (value: 0)

Below the input fields is a table with columns NO (1-4) and rows START, END, and COUNT.

NO	1	2	3	4
START	0	0	0	0
END	0	0	0	0
COUNT	0	0	0	0

No.	Contents	Description	Additional Description
①	Pattern No.	Set pattern number.	👁️ Change pattern number of 2.10.1 Edit Pattern Screen .
②	Pattern Repeat No.	Set pattern repeat number.	👁️ "0" is repeating unlimitedly.
③	Link Pattern	When the finish the running pattern, set the next pattern number continually.	
④	Pattern Name	Display pattern name.	▶ See 2.10.6 Pattern Name Setting Screen
⑤	Start Segment	Set the start segment number of repeat parts.	▶ Start Segment ≤ End Segment
⑥	End Segment	Set the end segment number of repeat parts.	
⑦	Count Segment	Set the number of repeat parts.	

2.10.2.1 Set Pattern Repeat

Set value of the pattern repeat	Process order							
<table border="1"> <tr> <td>PTN NO</td> <td>001</td> <td>TITLE: PROG PT001</td> </tr> <tr> <td>PTN RPT</td> <td>002</td> <td>LINK PTN</td> <td>003</td> </tr> </table>	PTN NO	001	TITLE: PROG PT001	PTN RPT	002	LINK PTN	003	▶ Pattern 1 → Pattern 1
PTN NO	001	TITLE: PROG PT001						
PTN RPT	002	LINK PTN	003					
<table border="1"> <tr> <td>PTN NO</td> <td>003</td> <td>TITLE: PROG PT003</td> </tr> <tr> <td>PTN RPT</td> <td>005</td> <td>LINK PTN</td> <td>002</td> </tr> </table>	PTN NO	003	TITLE: PROG PT003	PTN RPT	005	LINK PTN	002	▶ Pattern 3 → Pattern 3 → Pattern 3 → Pattern 3 → Pattern 3
PTN NO	003	TITLE: PROG PT003						
PTN RPT	005	LINK PTN	002					
<table border="1"> <tr> <td>PTN NO</td> <td>002</td> <td>TITLE: PROG PT002</td> </tr> <tr> <td>PTN RPT</td> <td>001</td> <td>LINK PTN</td> <td>000</td> </tr> </table>	PTN NO	002	TITLE: PROG PT002	PTN RPT	001	LINK PTN	000	▶ Pattern 2 → Pattern End
PTN NO	002	TITLE: PROG PT002						
PTN RPT	001	LINK PTN	000					

2.10.2.2 Process Order about Setting Method of the Repeat Parts(Segment Repeat)

▶ 1 segment ~ 8 segment(01 → 02 → 03 → 04 → 05 → 06 → 07 →08)

Example No.	Set value of the repeat parts			Process order
Example 1	NO	1	2	① 01 → 02 → 03 → 04 ② → 02 → 03 → 04 ③ → 03 → 04 → 05 ④ → 03 → 04 → 05 → 06 → 07 →08
	START	02	03	
	E N D	04	05	
	COUNT	02	02	
Example 2	NO	1	2	① 01 → 02 → 03 → 04 → 05 ② → 03 → 04 → 05 ③ → 02 → 03 → 04 ④ → 02 → 03 → 04 → 05 → 06 → 07 →08
	START	03	02	
	E N D	05	04	
	COUNT	02	02	
Example 3	NO	1	2	① 01 → 02 → 03 ② → 02 → 03 ③ → 05 → 06 ④ → 05 → 06 → 07 →08
	START	02	05	
	E N D	03	06	
	COUNT	02	02	
Example 4	NO	1	2	① 01 → 02 → 03 → 04 → 05 → 06 ② → 05 → 06 ③ → 02 → 03 ④ → 02 → 03 → 04 → 05 → 06 → 07 →08
	START	05	02	
	E N D	06	03	
	COUNT	02	02	
Example 5	NO	1	2	① 01 → 02 → 03 → 04 → 05 → 06 ② → 02 → 03 → 04 → 05 → 06 ③ → 03 → 04 ④ → 03 → 04 → 05 → 06 → 07 →08
	START	02	03	
	E N D	06	04	
	COUNT	02	02	
Example 6	NO	1	2	① 01 → 02 → 03 → 04 ② → 03 → 04 ③ → 02 → 03 → 04 → 05 → 06 ④ → 02 → 03 → 04 → 05 → 06 → 07 →08
	START	03	02	
	E N D	04	06	
	COUNT	02	02	

2.10.3 Edit File Screen

Figure 2-31. Edit File Screen

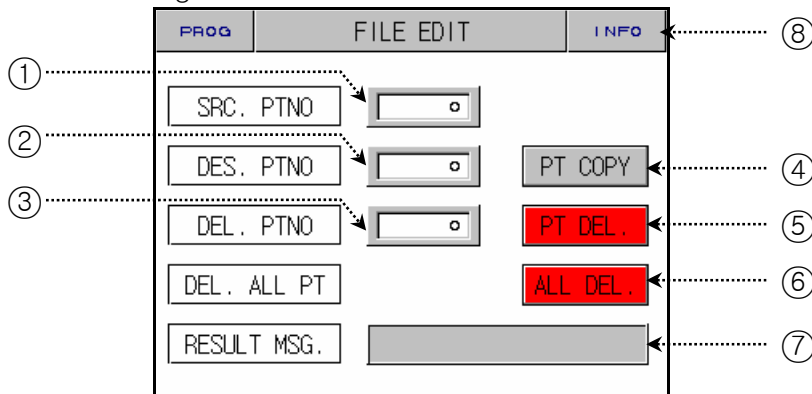

No.	Contents	Description	Additional Description	
①	Source Pattern	Set source pattern number.		
②	Destination Pattern	Set destination pattern number.		
③	Delete Pattern	Set pattern number for elimination.		
④	Pattern Copy Button	Pattern copy.	▶ You can not copy if source pattern is empty.	
⑤	Pattern Delete Button	Pattern delete.	☞ You never restore after confirm, so please check carefully.	
⑥	All Delete Button	All pattern delete.		
⑦	Execute Result	Display execute result.	▶ Message	
			Display Message	Description
			EXE DONE	Copy and delete is over.
			PT EMPTY	Source pattern is empty.
			PARA ERR	A wrong pattern number
			PT RUN	On running
PT USING	On using			
⑧	Info. Button	Move file information screen.	▶ See 2.10.1.5 File Information Screen	

2.10.4 Time Signal Setting Screen

Figure 2-32. TS Setting – First Screen

PROG		TIME SIGNAL SET	
TS NO(0~7)			
NO	ON TIME	OFF TIME	▲
00	TS OFF	TS OFF	▼
01	TS ON	TS ON	
02	00.00 HH.MM	00.00 HH.MM	
03	00.00 HH.MM	00.00 HH.MM	

①
②

Figure 2-33. TS Setting – Second Screen

PROG		TIME SIGNAL SET	
TS NO(0~7)			
NO	ON TIME	OFF TIME	▲
04	00.00 HH.MM	00.00 HH.MM	▼
05	00.00 HH.MM	00.00 HH.MM	
06	00.00 HH.MM	00.00 HH.MM	
07	00.00 HH.MM	00.00 HH.MM	

No.	Contents	Description	Additional Description
①	On Time	Set wait time for the time signal output.	<ul style="list-style-type: none"> ▶ See Figure 2-28. Time Signal Setting Key ▶ NO : 00 → No use time signal. ▶ NO : 01 → Use time signal. ▶ NO : 02 ~ 07 → Use time signal from On time to Off time.
②	Off Time	Set running time for the time signal output.	



Time Signal Operation

► Set value of the program pattern

SEG	TEMP	HUMI	TIME	T _S ₁	T _S ₂	T _S ₃	T _S ₄
01	40.00	90.0	8.00	00	00	00	00
02	40.00	90.0	8.00	04	05	06	07
03	50.00	90.0	8.00	00	00	00	00
04	-50.00	0.0	-0.00	00	00	00	00

► Set value of the time signal

NO	ON TIME	OFF TIME
04	00.00 HH.MM	04.00 HH.MM
05	02.00 HH.MM	02.00 HH.MM
06	00.00 HH.MM	10.00 HH.MM
07	04.00 HH.MM	06.00 HH.MM

► Time signal operation within segment

Setting		Time signal operation		
N SEG TIME >= ON TIME + OFF TIME It has not influence on next segment.	1. ON TIME = 00.00 (Time Signal NO : 04)	ON TIME SIGNAL1 OFF		
	2. ON TIME ≠ 00.00 (Time Signal NO : 05)	ON TIME SIGNAL2 OFF		
N SEG TIME < ON TIME + OFF TIME	3. ON TIME = 00.00 (Time Signal NO : 06)	ON TIME SIGNAL3 OFF		
	4. ON TIME ≠ 00.00 (Time Signal NO : 07)	ON TIME SIGNAL4 OFF		

2.10.5 Wait Operation Setting Screen

Figure 2-34. Wait Operation Setting Screen

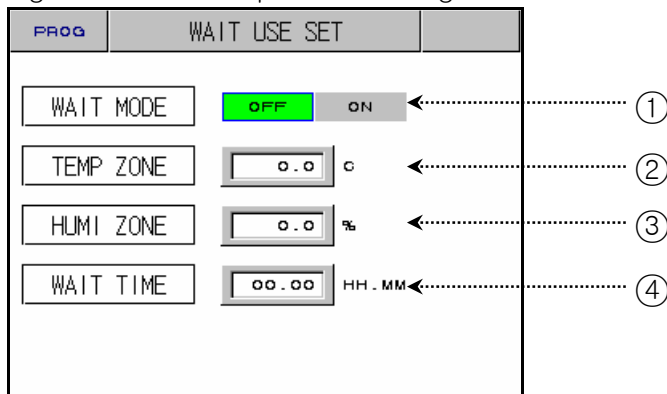

No.	Contents	Description	Additional Description
①	Wait Mode	Set On/Off for using Wait.	<ul style="list-style-type: none"> ▶ “OR” Condition → Temp. or Humi. PV does not reach the wait area before Wait Time. ▶ “AND” Condition → Temp. and HUmI. PV reach the wait area before Wait Time.
②	Temp. Zone	Set a Temp. zone.	
③	Humi. Zone	Set a Humi. zone.	
④	Wait Time	Set a Wait time.	<ul style="list-style-type: none"> ▶ Initial time (00.00) → Wait to infinity.



The relation of the wait operation and wait time

▶ WAIT ZONE : Temperature → TEMP ZONE, Humidity → HUMI ZONE.

① A case where wait release within Wait Time

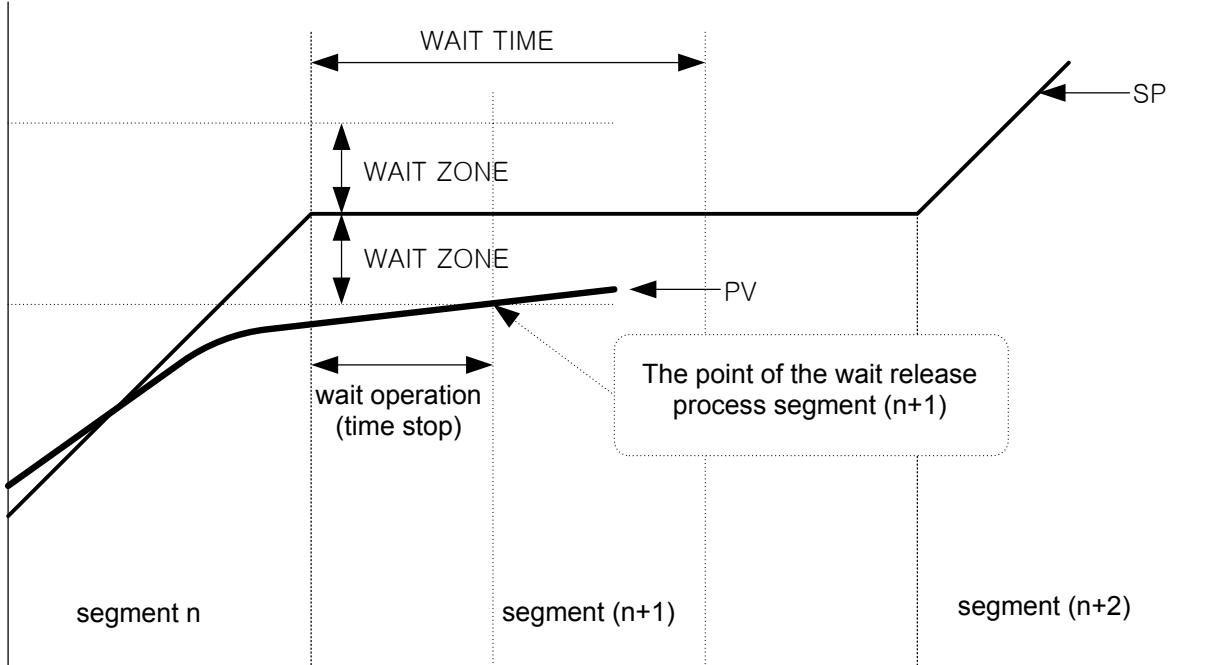

② A case where PV does not enter WZ(Wait Zone) within Wait Time

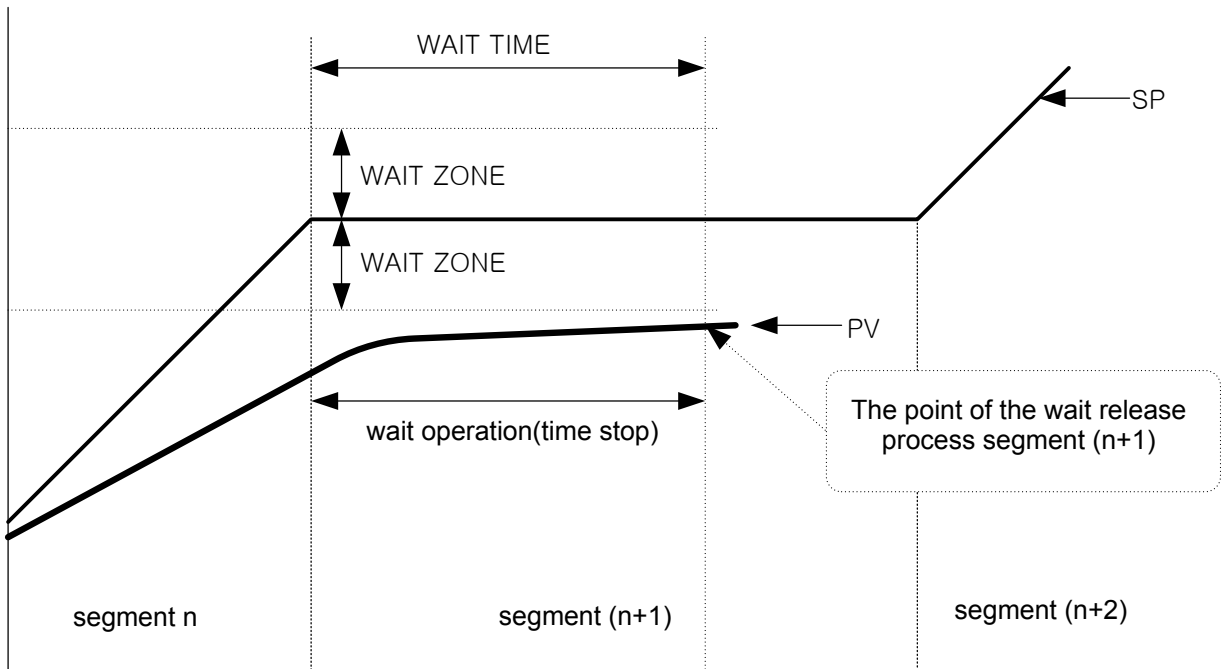

2.10.6 Pattern Name Setting Screen

Figure 2-35. Pattern Name Setting Screen

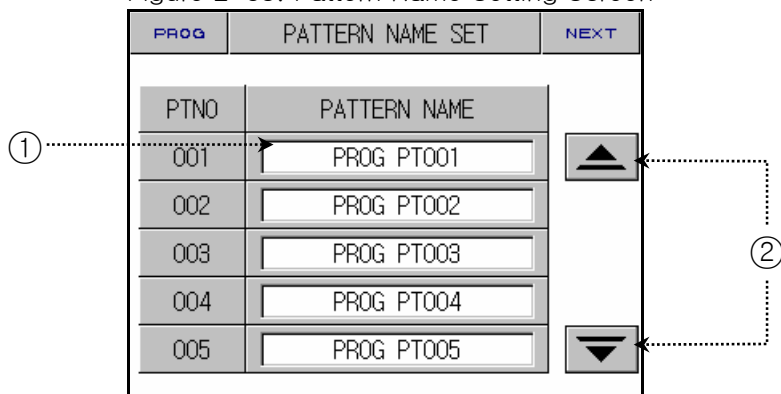

No.	Contents	Description	Additional Description
①	Pattern Name Button	Set pattern name.	▶ Max : use 10 character.
②	Page Move Button	Move pattern page.	▶ 1 Page : Display 5 pattern name.

2.10.6.1 The Method of the Pattern Name Setting

- ▶ The example of the pattern name setting : “TEST 8593W”.

Figure 2-36. Before Pattern Name Setting

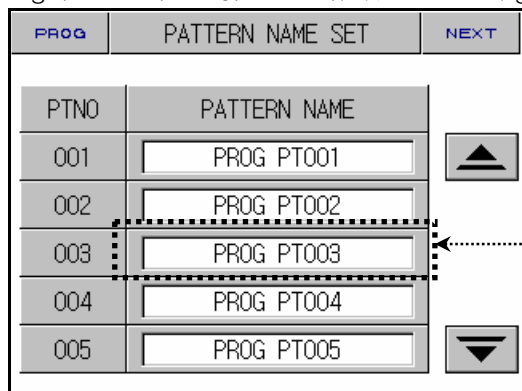
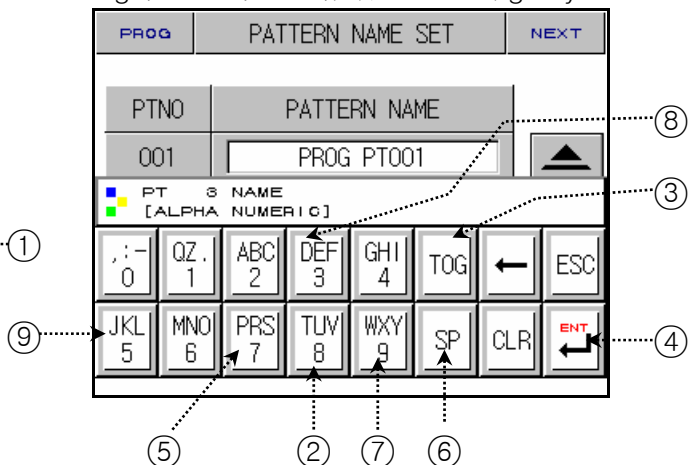

Figure 2-37. Pattern Name Setting Key



- 1) If user touch dot-rectangle areas(①) of Figure 2-36. Before Pattern Name Setting, Display Figure 2-37. Pattern Name Setting Key.
- 2) The order of the pattern name setting : ②→⑧→③→⑤→③→③→②→⑥→②→③→③→③→⑨→③→③→③→⑦→③→③→③→⑧→③→③→③→⑦→④

2.11 Display Setting Screen

► This is the screen of the display setting.

Figure 2-38. Display Setting Screen

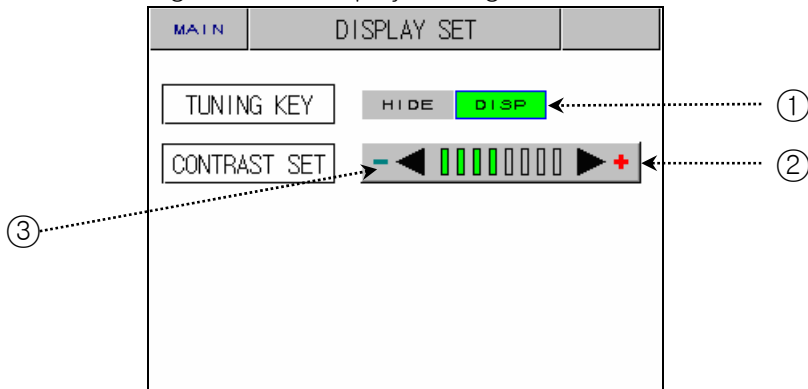

No.	Contents	Description	Additional Description
①	Tuning Key	Display or hide AT button.	► Display or hide T-AT/H-AT button of the Figure 2-14.
②	Bright Increase Button	One step increase.	► Set brightness using this button.
③	Bright Decrease Button	One step decrease.	

2.12 System Setting Screen

- ▶ This is the screen about the initial setting.
- ▶ Set password : See [2.12.8 Initial Display and Status Display Lamp Setting Screen](#)

Figure 2-39. System Setting Screen

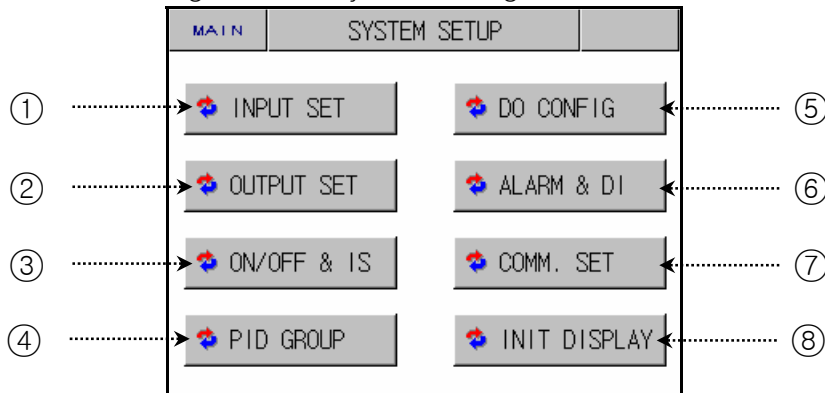

No.	Contents	Description	Additional Description
①	INPUT SET	Move input and input compensation setting screen.	▶ See 2.12.1 Input and Input Compensation Setting Screen
②	OUTPUT SET	Move control output and transmission setting screen.	▶ See 2.12.2 Control Output and Transmission Setting Screen
③	ON/OFF & IS SET	Move ON/OFF signal and IS signal setting screen.	▶ See 2.12.3 ON/OFF Signal and Inner Signal Setting Screen
④	PID GROUP	Move PID setting screen.	▶ See 2.12.4 PID Setting Screen
⑤	DO CONFIG	Move DO CONFIG setting screen.	▶ See 2.12.5 DO CONFIG Setting Screen
⑥	ALARM & DI	Move alarm and DI setting screen.	▶ See 2.12.6 Alarm and DI Error Name Setting Screen
⑦	COMM. SET	Move communication setting screen.	▶ See 2.12.7 Communication Setting Screen
⑧	INIT DISPLAY	Move initial display and status display lamp setting screen.	▶ See 2.12.8 Initial Display and Status Display Lamp Setting Screen

2.12.1 Input and Input Compensation Setting Screen

2.12.1.1 Temperature Input Setting

Figure 2-40. Temp. Input Setting – PT_1

Figure 2-41. Temp. Input Setting – DCV

No.	Contents	Description	Additional Description
①	SENSOR TYPE	Select sensor type.	
②	TEMP RANGE	Set temperature range.	<ul style="list-style-type: none"> ▶ PT_1 : -90.00 ~ 200.00 °C ▶ PT_2 : -100.0 ~ 300.0 °C ▶ DCV : -1.000 ~ 2.000 V
③	TEMP BIAS	Set temperature bias.	▶ See 2.12.1.4 Sensor BIAS Setting
④	FILTER TIME	Set filter time.	
⑤	TEMP SCALE	A case where sensor type is "DCV", set temperature scale.	

☞ Sensor type can not change on running.

2.12.1.2 Humidity Input Setting

Figure 2-42. Humi. Input Setting – PT

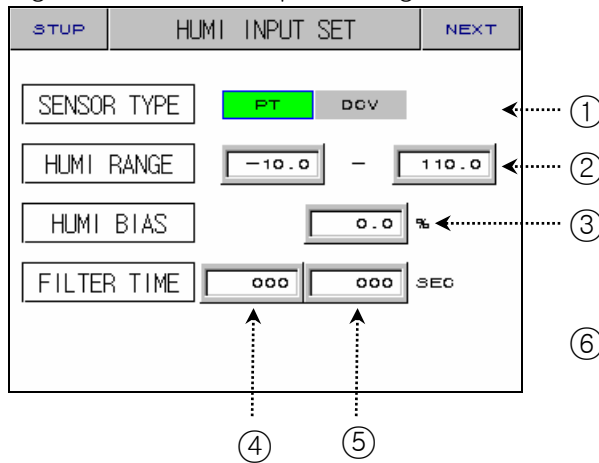
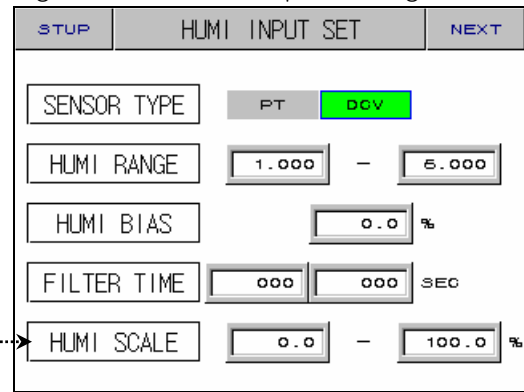

Figure 2-43. Humi. Input Setting – DCV



No.	Contents	Description	Additional Description
①	SENSOR TYPE	Select sensor type.	
②	HUMI RANGE	Set humidity range.	▶ PT : -10.0 ~ 110.0 °C ▶ DCV : 1.000 ~ 5.000 V
③	HUMI BIAS	Set humidity bias.	
④	DISPLAY FILTER	Set for decreasing when PV is unstable due to sensitive sensor response under normal control.	
⑤	FILTER TIME	Set filter time.	
⑥	HUMI SCALE	A case where sensor type is "DCV", set humidity scale.	

☞ Sensor type can not change on running.

2.12.1.3 Input Display Screen

Figure 2-44. Input Display Screen

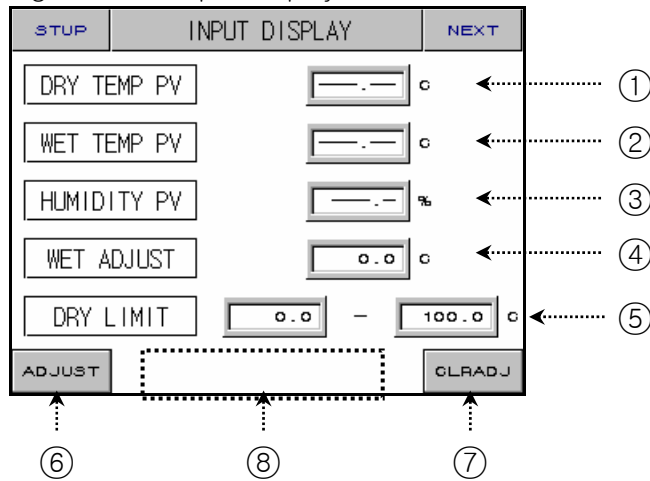

No.	Contents	Description	Additional Description
①	DRY TEMP PV	Display dry temperature PV.	
②	WET TEMP PV	Display wet temperature PV.	▶ PT : -10.0 ~ 110.0 °C ▶ DCV : 1.000 ~ 5.000 V
③	HUMIDITY PV	Display humidity PV.	
④	WET ADJUST	Set wet temperature bias.	
⑤	DRY LIMIT	Set limit of the dry temperature.	
⑥	ADJUST BUTTON	wet temperature = dry temperature (① = ② + ④)	☞ It is use only at sensor type is "PT".
⑦	CLEAR ADJUST BUTTON	Initialize WET ADJUST : 0.0.	
⑧	HIDDEN BUTTON	Move Figure 2.12.1.4	▶ See 2.13 Password Input Screen ▶ See 2.12.1.4 Sensor BIAS Setting

☞ A case where sensor line is opened, Display "-----.--" and control output is fixed 0.0%.



Engineering Units – EU, EUS

- ▶ The explanation of the EU and EUS.
- ▶ EU() : Engineering unit's value in a range of instrument.
- ▶ EUS() : Engineering unit's range in a span of instrument.

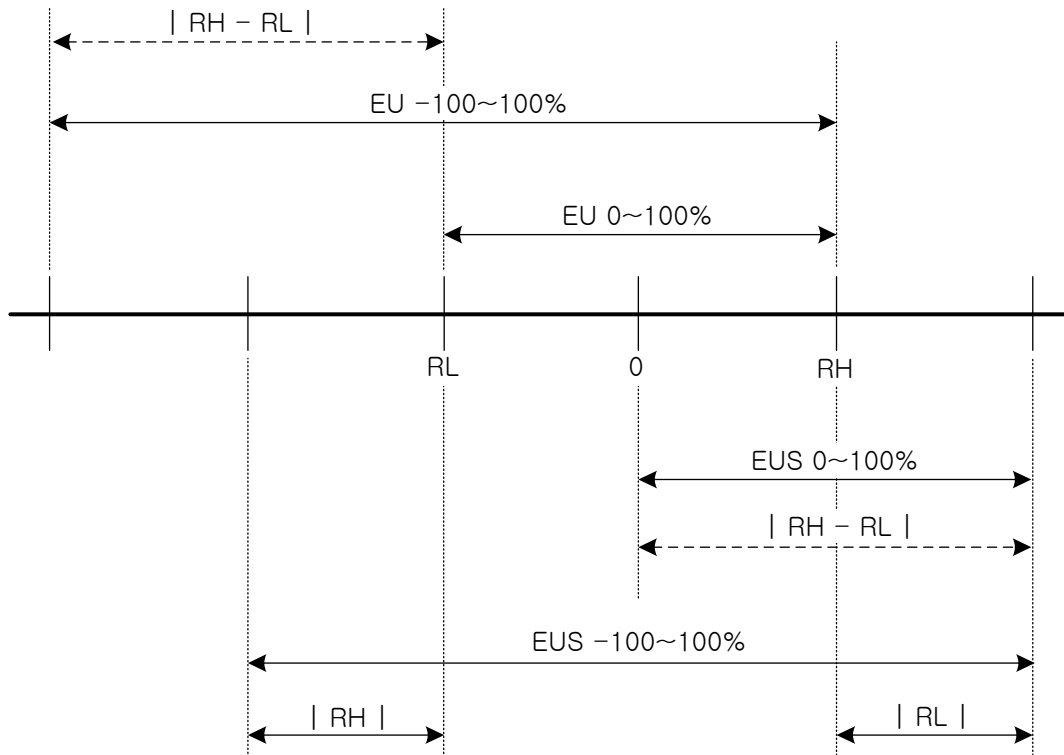

- ▶ The range of the EU() and EUS()

	RANGE	CENTER POINT
EU 0 ~ 100%	RL ~ RH	$ RH - RL / 2 + RL$
EU -100 ~ 100%	$-(RH - RL + RL) \sim RH$	RL
EUS 0 ~ 100%	$0 \sim RH - RL $	$ RH - RL / 2$
EUS -100 ~ 100%	$- RH - RL \sim RH - RL $	0

- ▶ INPUT = TEMP(PT_1)
- ▶ RANGE = -50.0°C(RL) ~ 150.0°C(RH)

	RANGE	CENTER POINT
EU 0 ~ 100%	- 50.0 ~ 150.0°C	50.0°C
EU -100 ~ 100%	- 250.0 ~ 150.0°C	- 50.0°C
EUS 0 ~ 100%	0 ~ 200.0°C	100.0°C
EUS -100 ~ 100%	- 200.0 ~ 200.0°C	0.0°C

2.12.1.4 Sensor BIAS Setting

► This is the screen about sensor bias setting.

Figure 2-45. Sensor BIAS Setting – Humi. PT

STUP	SENSOR PEACE BIAS			
	POINT 1	POINT 2	POINT 3	POINT 4
DDV	0.0	0.0	0.0	0.0
DPV	-50.0	150.0	150.0	150.0
WDV	0.0	0.0	0.0	0.0
WPV	-10.0	110.0	110.0	110.0
DRY TEMP	c			
WET TEMP	c			
	HUMIDITY %			

Figure 2-46. Sensor BIAS Setting – Humi. DCV

STUP	SENSOR PEACE BIAS			
	POINT 1	POINT 2	POINT 3	POINT 4
DDV	0.0	0.0	0.0	0.0
DPV	-50.0	150.0	150.0	150.0
RDV	0.0	0.0	0.0	0.0
RPV	0.0	100.0	100.0	100.0
DRY TEMP	c			
WET TEMP	c			
	HUMIDITY %			

No.	Contents	Description	Additional Description
①	DRY TEMP DIFFERENCE VALUE	Set dry temperature difference value.	
②	DRY TEMP REFERENCE POINT	Set dry temperature difference point.	
③	WET TEMP DIFFERENCE VALUE	Set wet temperature difference value.	
④	WET TEMP REFERENCE POINT	Set wet temperature difference point.	
⑤	BIASED DRY TEMP PV	Set biased dry temperature PV.	
⑥	BIASED WET TEMP PV	Set biased wet temperature PV.	
⑦	BIASED HUMIDITY PV	Set biased humidity PV.	
⑧	HUMIDITY DIFFERENCE VALUE	Set humidity difference value.	☞ Humidity indicates relative humidity.
⑨	HUMIDITY REFERENCE POINT	Set humidity difference point.	



Sensor BIAS Setting

- ▶ This is a range input correction into dry temperature.
- ▶ Wet temperature and humidity have The same range input correction.
- ▶ S.PV = Sensor Temperature, B.PV = The temperature after correction, RL = Range Low, RH = Range High
- ▶ POINTn.DPV = Basic Temperature, POINTn.DDV = Correction Temperature (n = 1, 2, 3, 4)

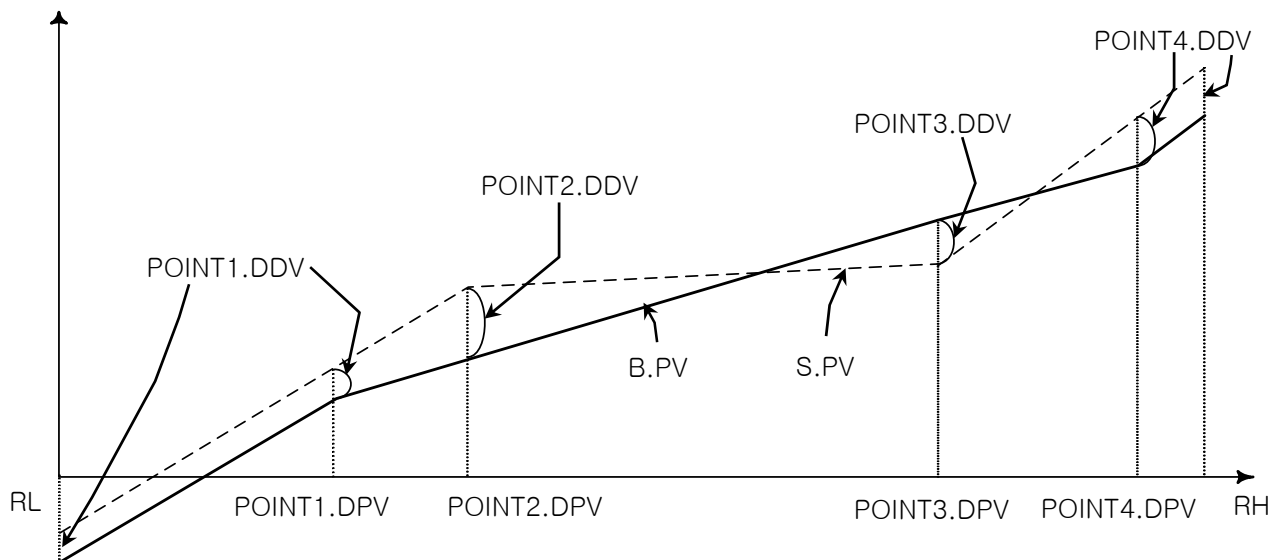

- ▶ B.PV of the RL ~ POINT1 range.

$$= S.PV + POINT1.DDV$$

- ▶ B.PV of the POINT1 ~ POINT2 range.

$$= S.PV + (S.PV - POINT1.DPV) \times \frac{(POINT2.DDV - POINT1.DDV)}{(POINT2.DPV - POINT1.DPV)} + POINT1.DDV$$

- ▶ B.PV of the POINT2 ~ POINT3 range.

$$= S.PV + (S.PV - POINT2.DPV) \times \frac{(POINT3.DDV - POINT2.DDV)}{(POINT3.DPV - POINT2.DPV)} + POINT2.DDV$$

- ▶ B.PV of the POINT3 ~ POINT4 range.

$$= S.PV + (S.PV - POINT3.DPV) \times \frac{(POINT4.DDV - POINT3.DDV)}{(POINT4.DPV - POINT3.DPV)} + POINT3.DDV$$

- ▶ B.PV of the POINT4 ~ RH range.

$$= S.PV + POINT4.DDV$$

2.12.2 Control Output and Transmission Setting Screen

2.12.2.1 Control Output Setting

Figure 2-47. Temp. Control Output Setting

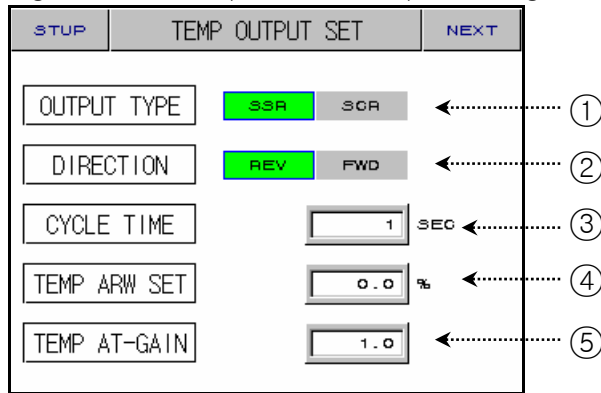
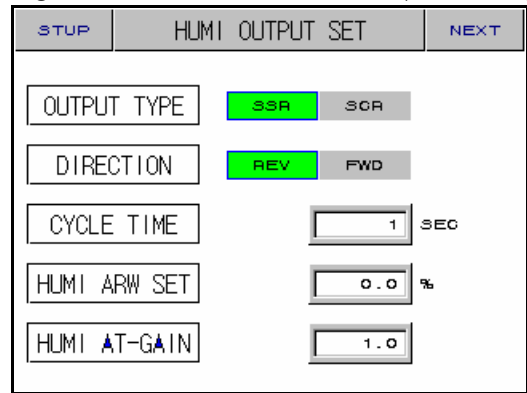
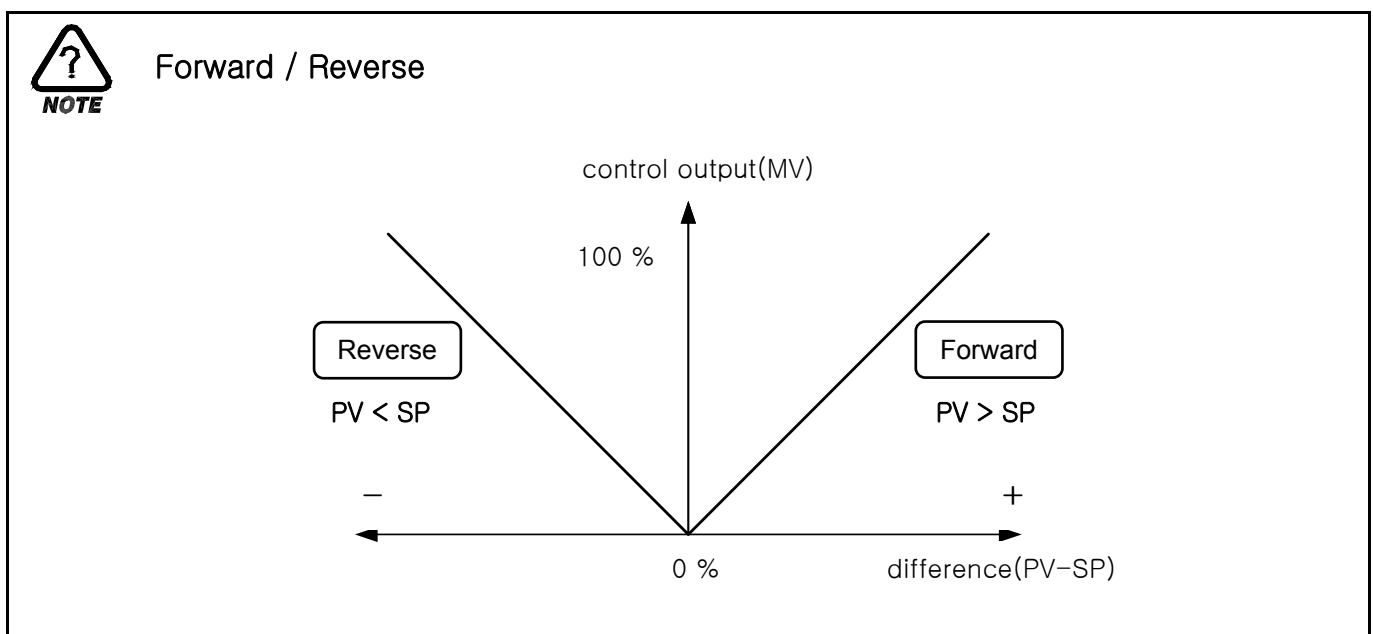

Figure 2-48. Humi. Control Output Setting



No.	Contents	Description	Additional Description
①	OUTPUT TYPE	Set control output type.	
②	DIRECTION	Select of PID direction (Forward/Reverse)	
③	CYCLE TIME	Set output cycle. It is only for SSR (Solid State Relay) type.	
④	ANTI RESET WIND-UP	Control reset wind-up.	
⑤	AT GAIN	Use PID value control.	▶ control output = PID X GAIN





CYCLE TIME

- ▶ It is only for SSR(Solid State Relay) type.
- ▶ 1 Cycle : from ON to OFF.
- ▶ Cycle time : 10 seconds

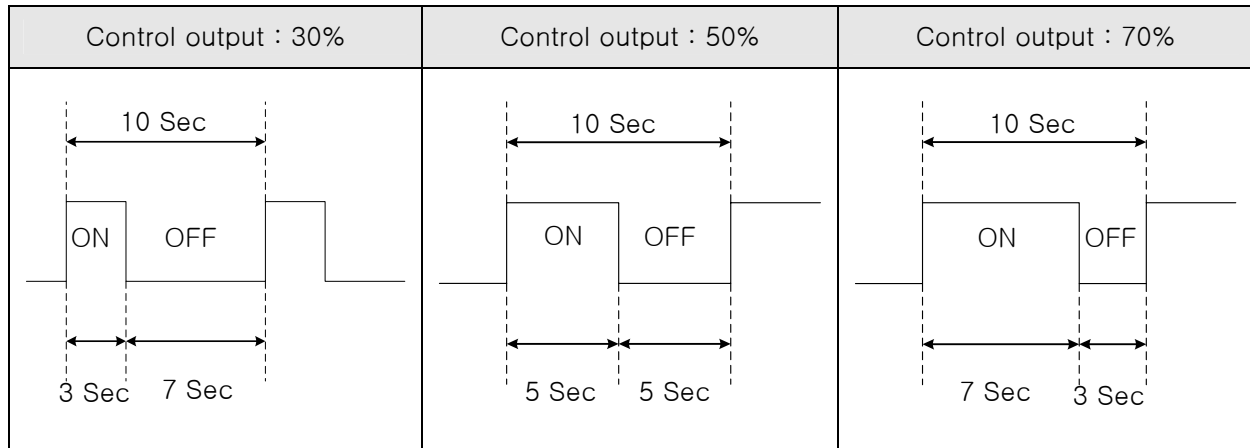

AT GAIN(AUTO TUNING GAIN)

- ▶ User uses AT GAIN for change of the control character.
 - ▶ AT GAIN controls that following control object and character.
- ① AT GAIN < 1.0
→ RESPONSE TIME is fast, but HUNTING is extreme.
 - ② AT GAIN > 1.0
→ OVER SHOOT is decreased, but RESPONSE TIME is slow.

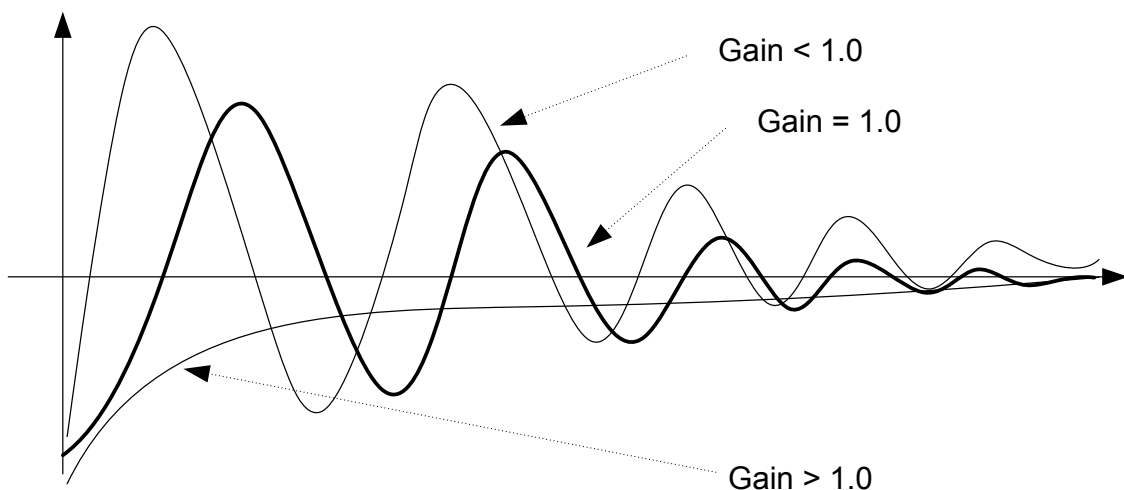



ANTI RESET WIND-UP

- ▶ Effective method for the control at the external shock.
- ▶ Not running (I = 0).

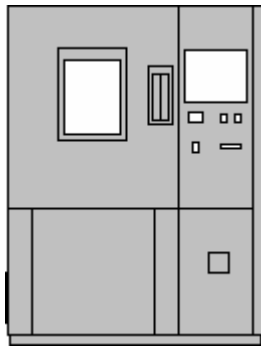

chamber

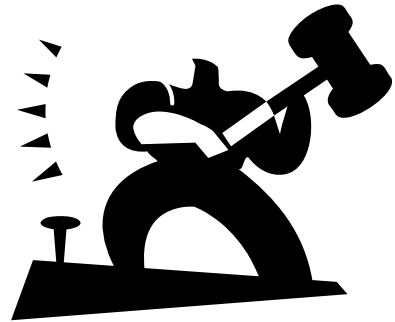
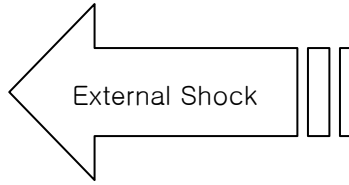

- ▶ control output(MV)
MV = P + I + D

Open Door

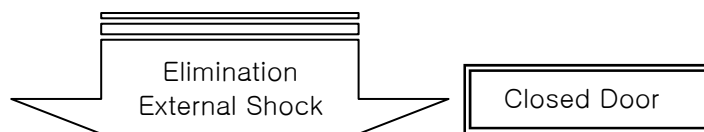
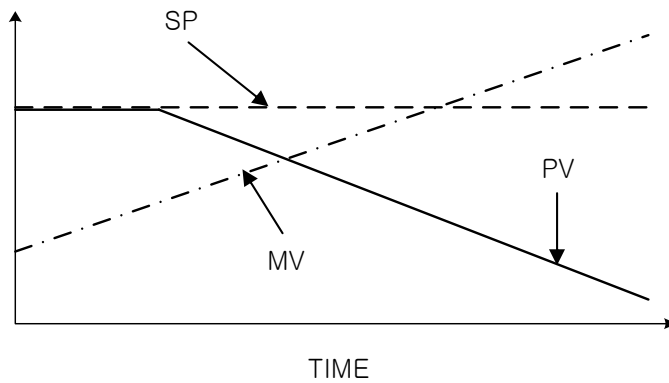

Not use ARW Function

Use ARW Function

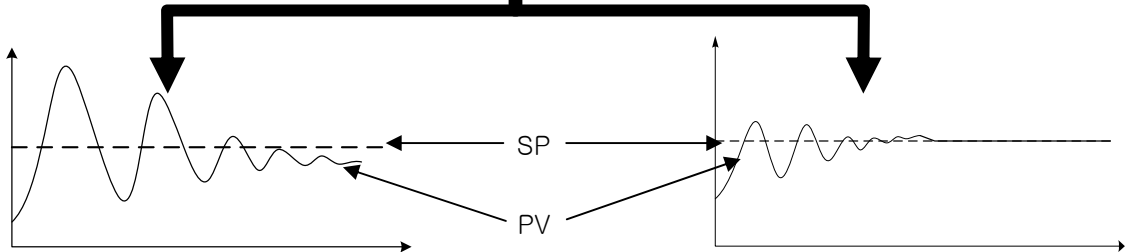

▶ It is spent long time.

▶ It is spent short time.

2.12.2.2 Transmission Output Setting

Figure 2-49. Transmission Output Setting

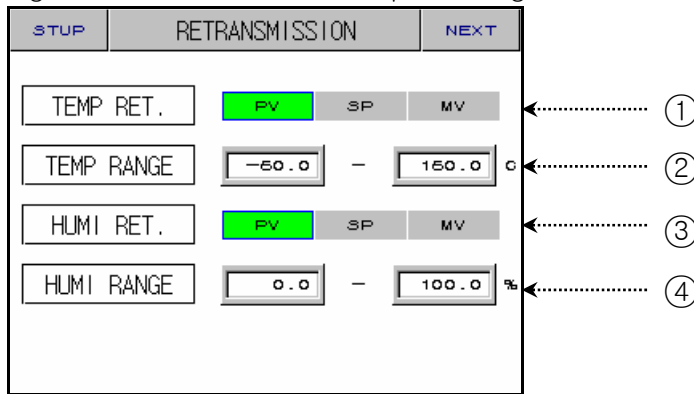

No.	Contents	Description	Additional Description
①	TEMP RET.	Select type of the temperature transmission.	
②	TEMP RET. RANGE	Set range of the temperature transmission.	▶ Not display, if temperature transmission type is "MV".
③	HUMI RET.	Select type of the humidity transmission.	
④	HUMI RET. RANGE	Set range of the humidity transmission.	▶ Not display, if humidity transmission type is "MV".

☞ Transmission output is 4~20mA.

If you want to use transmission output into 1~5V, Use 250Ω RN-TYPE resistance (accuracy resistance).

NOTE Output is affected by transmission output

① In this case transmission output type is "PV" or "SP"

② In this case transmission output type is "MV"

2.12.3 ON/OFF Signal and Inner Signal Setting Screen

2.12.3.1 ON/OFF Signal

- ▶ Set 4 ON/OFF Signal.

Figure 2-50. ON/OFF Signal Setting Screen

NO	LSP	MSP	HSP	HD	LD
T1	-50.0	-50.0	-50.0	0.0	0.0
T2	-50.0	-50.0	-50.0	0.0	0.0
T3	-50.0	-50.0	-50.0	0.0	0.0

No.	Contents	Description	Additional Description
①	NEXT BUTTON	Move next page.	▶ See 2.12.3.2 Inner Signal
②	LOW SP	Set low SP on ON/OFF.	▶ See 2.12.5 DO CONFIG Setting Screen
③	MIDDLE SP	Set middle SP on ON/OFF.	
④	HIGH SP	Set high SP on ON/OFF.	
⑤	HIGH DIFFERENCE	Deviation value for high zone.	
⑥	LOW DIFFERENCE	Deviation value for low zone.	



ON/OFF Signal Action

NOTE

- ▶ DELAY TIME is setting at Figure 2.12.5 DO CONFIG Setting Screen.
- ▶ DELAY TIME applies to Power On in the first place.
- ▶ LSP = LOW SP, MSP = MIDDLE SP, HSP = HIGH SP, NPV = NOW PV, NSP = NOW SP
- ▶ LD = LOW DIFFERENCE, HD = HIGH DIFFERENCE, T = ON/OFF SIGNAL

▶ ON/OFF Signal Action	
Setting	ON/OFF Signal Action
<p>① $NPV < LSP$</p> <p>▶ ALWAYS : OFF</p>	
<p>② $LSP \leq NPV < MSP$</p> <p>▶ $NPV \geq NSP - LD$: ON</p> <p>▶ $NPV < NSP - LD$: OFF</p>	
<p>③ $MSP < NPV \leq HSP$</p> <p>▶ $NPV \geq NSP + HD$: ON</p> <p>▶ $NPV < NSP + HD$: OFF</p>	
<p>④ $NPV > HSP$</p> <p>▶ ALWAYS : OFF</p>	

2.12.3.2 Inner Signal

► Set 8 Inner Signal.

Figure 2-51. Inner Signal Setting Screen

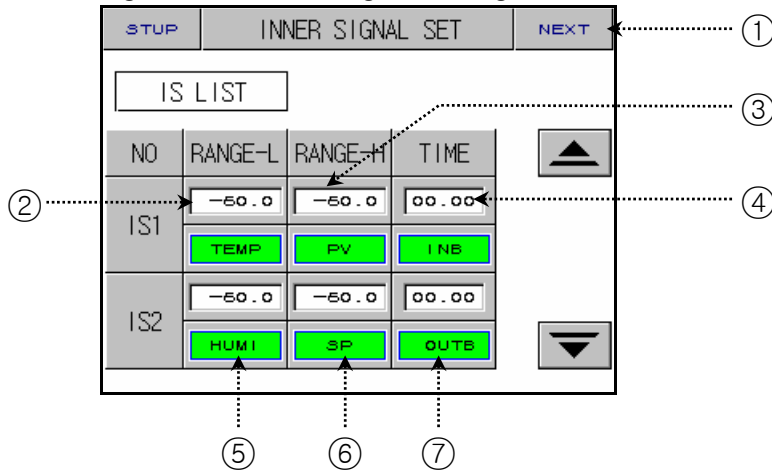

No.	Contents	Description	Additional Description
①	NEXT BUTTON	Move ON/OFF signal setting screen.	► See 2.12.3.1 ON/OFF Signal
②	RANGE LOW	Set low value of the inner signal.	
③	RANGE HIGH	Set high value of the inner signal.	
④	DELAY TIME	Set delay time of the inner signal.	► See output time of the 1REF, 2REF of 2.12.5 DO CONFIG Setting Screen
⑤	ITEM BUTTON	Select item of the inner signal.	
⑥	TYPE BUTTON	Select type of the inner signal.	<ul style="list-style-type: none"> ► SP : Present setting value ► PV : Present indication value ► TSP : Target setting value
⑦	BAND BUTTON	Select BAND of the inner signal.	

☞ If SLOPE is setting up, “TSP” is the same action with “TSP” of the program control at Fix running. But if SLOPE is not setting up, “TSP” is the same action with “SP”.

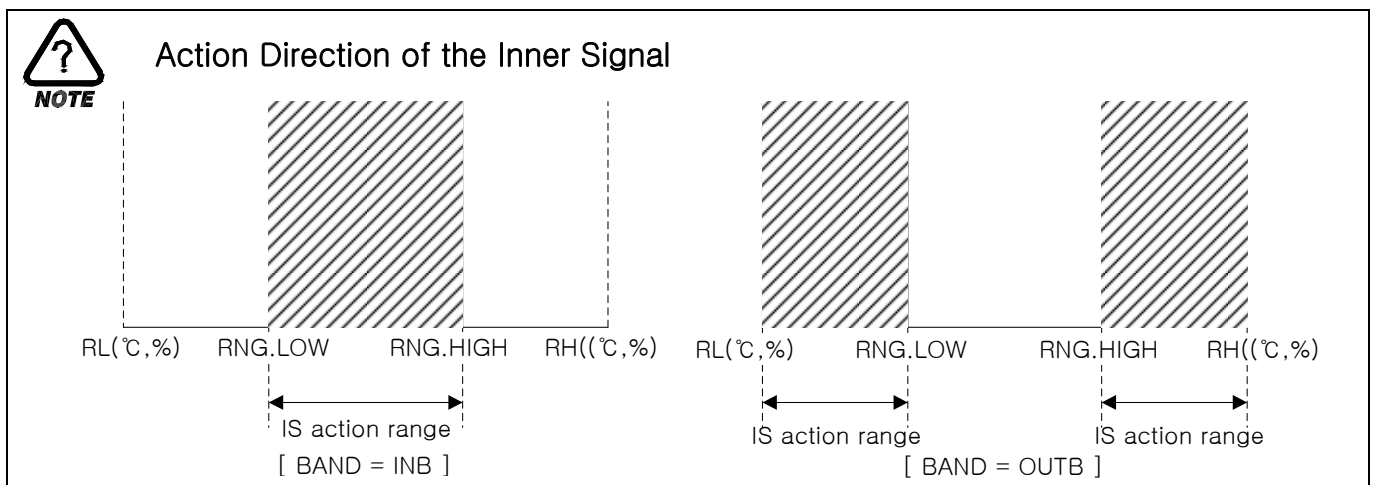



Inner Signal Action

Inner Signal Action	
Setting	Inner Signal Action
<ul style="list-style-type: none"> ▶ INPUT = 0.0 ~ 100.0 → EUS 0.5% = 0.5 ▶ OPER. MODE = PROG ▶ ITEM = HUMI ▶ TYPE = PV ▶ RANGE LOW = 30.0% ▶ RANGE HIGH = 50.0% ▶ DIRECT = IN BAND ▶ DELAY TIME = 00.00 	
<ul style="list-style-type: none"> ▶ INPUT = 0.0 ~ 100.0 → EUS 0.5% = 0.5 ▶ OPER. MODE = PROG ▶ ITEM = HUMI ▶ TYPE = PV ▶ RANGE LOW = 30.0% ▶ RANGE HIGH = 50.0% ▶ DIRECT = OUT BAND ▶ DELAY TIME = 00.00 	
<ul style="list-style-type: none"> ▶ INPUT = 0.0 ~ 100.0 ▶ OPER. MODE = PROG ▶ ITEM = HUMI ▶ TYPE = SP ▶ RANGE LOW = 30.0% ▶ RANGE HIGH = 50.0% ▶ DIRECT = IN BAND ▶ DELAY TIME = 00.10 	
<ul style="list-style-type: none"> ▶ INPUT = 0.0 ~ 100.0 ▶ OPER. MODE = PROG ▶ ITEM = HUMI ▶ TYPE = TSP ▶ RANGE LOW = 30.0% ▶ RANGE HIGH = 50.0% ▶ DIRECT = OUT BAND ▶ DELAY TIME = 00.00 	

2.12.4 PID Setting Screen

2.12.4.1 PID Range Setting

► It is composed of 6 Temp./Humi. PID and 3 Temp. PID.

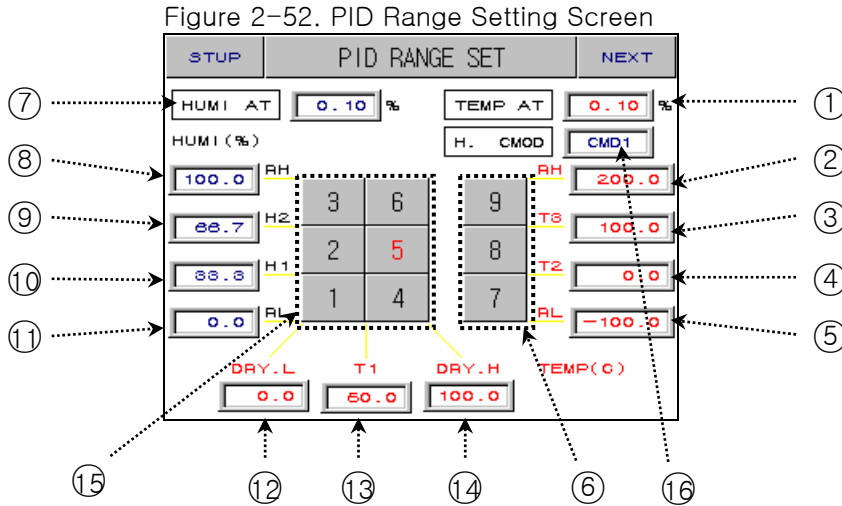

No.	Contents	Description	Additional Description
①	TEMP AUTO TUNING POINT	Set temperature auto tuning point.	
②	TEMP RANGE HIGH	Set temperature range high.	► A case TEMP.RH(TEMP RANGE HIGH) of <u>2.12.1.1 Temperature Input Setting</u> is changed, it is changed. ☞ Not modify.
③	TEMP REFER_POINT3	Set temperature reference point2 and point3.	► (TEMP.RH - TEMP.RL) X 2 / 3
④	TEMP REFER_POINT2		► (TEMP.RH - TEMP.RL) X 1 / 3
⑤	TEMP RANGE LOW.	Set temperature range low.	► A case TEMP.RL(TEMP RANGE LOW) of <u>2.12.1.1 Temperature Input Setting</u> is changed, it is changed. ☞ Not modify.
⑥	TEMP ONLY PID GROUP	PID group for control temperature.	► Move PID group setting page.
⑦	HUMI AUTO TUNING POINT	Set humidity auto tuning point.	
⑧	HUMI RANGE HIGH	Set humidity range high.	
⑨	HUMI REFER_POINT2	Set humidity reference point.	► (HUMI.RH - HUMI.RL) X 2 / 3
⑩	HUMI REFER_POINT1		► (HUMI.RH - HUMI.RL) X 1 / 3
⑪	HUMI RANGE LOW.	Set humidity range low.	

⑫	DRY LIMIT LOW	Set dry limit low.	▶ A case DRY LIMIT LOW of 2.12.1.3 Input Display Screen is changed, it is changed. 👁 Not modify.
⑬	TEMP REFERENCE POINT1	Set temperature reference point1.	▶ A case DRY LIMIT LOW or HIGH of 2.12.1.3 Input Display Screen is changed, it is changed into (DRY.L + DRY.H) / 2 value.
⑭	DRY LIMIT HIGH	Set dry limit high.	▶ A case DRY LIMIT HIGH of 2.12.1.3 Input Display Screen is changed, it is changed. 👁 Not modify
⑮	TEMP·HUMI PID GROUP	PID group for control temperature and humidity.	▶ Move PID group setting page.
⑯	H.CMOD	Select control mode at humidity	▶ CMD0 : If you use wide control object(Ex:Clean Room) selecting DCV sensor at humidity, you can get a stable result. ▶ CMD1 : If you use narrow control object(Ex:Chamber) selecting PT or DCV sensor at humidity, you can get a stable result.



PID Group

NOTE

PID group for control temperature and humidity		PID group for control temperature
GROUP 3	GROUP 6	GROUP 9
DRY.L ≤ TEMP SP ≤ T1 H2 < HUMI SP ≤ HUMI RH	T1 < TEMP SP < DRY.H H2 < HUMI SP ≤ HUMI RH	T3 < TEMP SP ≤ TEMP RH HUMI SP = HUMI RL
GROUP 2	GROUP 5	GROUP 8
DRY.L ≤ TEMP SP ≤ T1 H1 < HUMI SP ≤ H2	T1 < TEMP SP < DRY.H H1 < HUMI SP ≤ H2	T2 < TEMP SP ≤ T3 HUMI SP = HUMI RL
GROUP 1	GROUP 4	GROUP 7
DRY.L ≤ TEMP SP ≤ T1 HUMI RL < HUMI SP ≤ H1	T1 < TEMP SP < DRY.H HUMI RL < HUMI SP ≤ H1	TEMP RL ≤ TEMP SP ≤ T2 HUMI SP = HUMI RL



AUTO TUNING and TUNING POINT

- ▶ Auto tuning is the function that controller is set up most suitable PID number automatically.
- ▶ Auto tuning is calculated with P, I, D as a cycle and amplitude.
- ▶ Auto tuning is possible at Fix RUN only and set P, I, D vaule automatically.

▶ Auto Tuning Action

Setting

- ▶ OPER. MODE = FIX RUN
- ▶ INPUT = TEMP(PT_1)
- ▶ RANGE = $-50.00^{\circ}\text{C} \sim 150.00^{\circ}\text{C}$
- ▶ TEMP AUTO TUNING POINT = 0.10%
→ EUS 0.10% = 0.2°C
- ▶ SP = 50.0°C
- ▶ OL = 0.0%
- ▶ OH = 100.0%

Auto Tuning Action

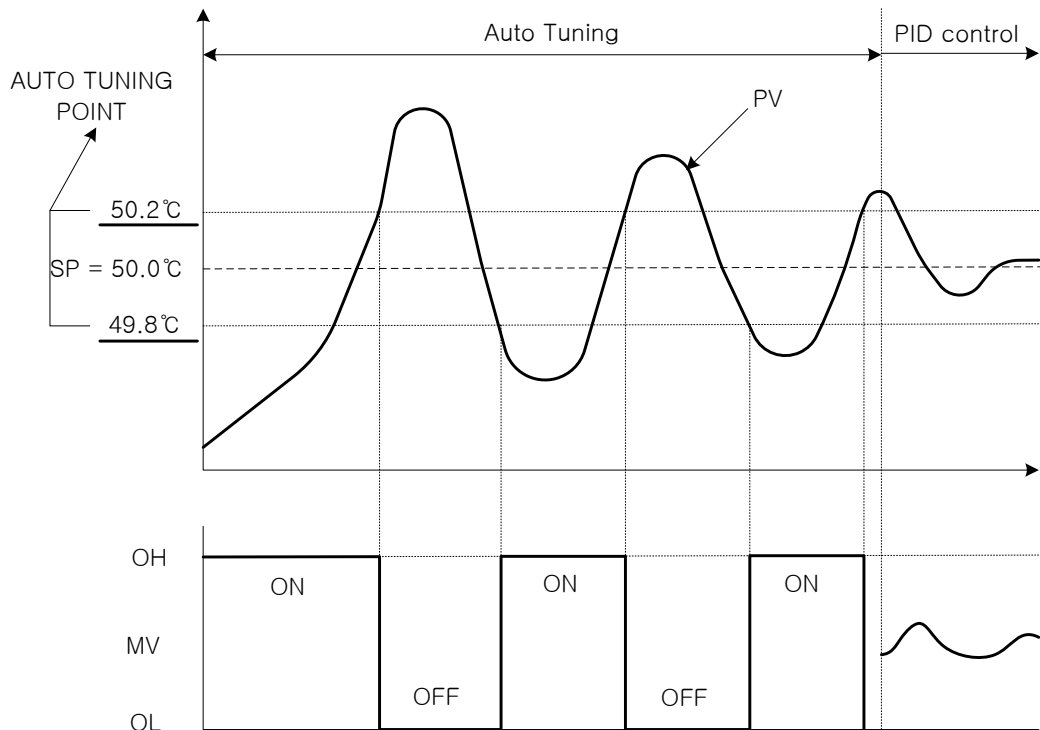

- ▶ The caution about Auto Tuning.
 - Though SP has changed at Auto Tuning, Tuning Point is not changed. And changed SP start control as TSP(Target SP) after bring Auto Tuning to an end.
 - If Burn Out is occurred at Auto Tuning, Auto Tuning is stopped. Keep up previous P, I, D setting value.
 - If two cycle time is over 24 hours, Auto Tuning is stopped.
 - Though you can change P, I, D setting value at Auto Tuning, its value is changed re-calculable value at Auto Tuning is stopped.
 - If Auto Tuning is stopped by compulsion, P,I,D value keep up previous setting value.

☞ The order of the Auto Tuning

- ① Auto Tuning of the temperature side.
- ② Auto Tuning of the humidity side.

2.12.4.2 PID Group(PID1~PID9) Setting

► It is possible that you set with user manual.

Figure 2-53. PID Group – Control Temp.&Humi.

STUP	PID GROUP 1		NEXT
	TEMP	HUMI	▲
P	5.0 %	5.0 %	
I	120 s	120 s	
D	30 s	30 s	
OH	100.0 %	100.0 %	
OL	0.0 %	0.0 %	▼

Figure 2-54. PID Group – Control Temp.

STUP	PID GROUP 7		NEXT
	TEMP		▲
①	P	5.0 %	
②	I	120 s	
③	D	30 s	
④	OH	100.0 %	
⑤	OL	0.0 %	▼

No.	Contents	Description	Additional Description
①	PROPORTIONAL BAND	Set proportional band.	
②	INTEGRAL TIME	Set integral time.	☞ Integral action remove remaining derivation that it is occurred P action.
③	DERIVATIVE TIME	Set derivative time.	☞ Control external shock.
④	OUTPUT LIMIT HIGH	Set output limit high.	► OH > OL
⑤	OUTPUT LIMIT LOW	Set output limit low.	☞ If OH, OL are changed, they are applied to control output at Auto Tuning.

2.12.5 DO CONFIG Setting Screen

► This is the screen about the DO CONFIG Setting.

Figure 2-55. DO CONFIG Setting - 1 Screen

STUP		DO CONFIGURATION		NEXT	
IS LIST					
DO	RELAY	DO	RELAY		
IS1	<input type="checkbox"/>	IS5	<input type="checkbox"/>		
IS2	<input type="checkbox"/>	IS6	<input type="checkbox"/>		
IS3	<input type="checkbox"/>	IS7	<input type="checkbox"/>		
IS4	<input type="checkbox"/>	IS8	<input type="checkbox"/>		

Figure 2-56. DO CONFIG Setting - 2 Screen

STUP		DO CONFIGURATION		NEXT	
TS/AL LIST					
DO	RELAY	DO	RELAY		
TS1	<input type="checkbox"/>	AL1	<input type="checkbox"/>		
TS2	<input type="checkbox"/>	AL2	<input type="checkbox"/>		
TS3	<input type="checkbox"/>	AL3	<input type="checkbox"/>		
TS4	<input type="checkbox"/>	AL4	<input type="checkbox"/>		

Figure 2-57. DO CONFIG Setting - 3 Screen

STUP		DO CONFIGURATION		NEXT	
T LIST					
DO	RELAY	CPARA			
T1	<input type="checkbox"/>	00.00 MM.SS			
T2	<input type="checkbox"/>	00.00 MM.SS			
T3	<input type="checkbox"/>	00.00 MM.SS			
T4	<input type="checkbox"/>	00.00 MM.SS			

Figure 2-58. DO CONFIG Setting - 4 Screen

STUP		DO CONFIGURATION		NEXT	
OTHER LIST					
DO	RELAY	CPARA			
T.RUN	<input type="checkbox"/>	0 SEC			
H.RUN	<input type="checkbox"/>	0 SEC			
T.UP	<input type="checkbox"/>	0.0 C			
T.SK	<input type="checkbox"/>	0 MIN			

Figure 2-59. DO CONFIG Setting - 5 Screen

STUP		DO CONFIGURATION		NEXT	
OTHER LIST					
DO	RELAY	CPARA			
T.DN	<input type="checkbox"/>	0.0 C			
H.UP	<input type="checkbox"/>	0.0 %			
H.SK	<input type="checkbox"/>	0 MIN			
H.DN	<input type="checkbox"/>	0.0 %			

Figure 2-60. DO CONFIG Setting - 6 Screen

STUP		DO CONFIGURATION		NEXT	
OTHER LIST					
DO	RELAY	CPARA			
DRAIN	<input type="checkbox"/>	0.0 MIN			
	RANGE LOW	RANGE HIGH			
	0.0 C	100.0 C			

Figure 2-61. DO CONFIG Setting - 7 Screen

STUP		DO CONFIGURATION		NEXT	
OTHER LIST					
DO	RELAY	CPARA			
ERROR	<input type="checkbox"/>	0.0 MIN			
PTEND	<input type="checkbox"/>	0.0 SEC			
1REF	<input type="checkbox"/>	0 SEC			
2REF	<input type="checkbox"/>	0.0 MIN			

No.	Contents	Description	Additional Description
①	INNER SIGNAL	Set relay number for the inner signal output.	▶ See <u>2.12.3 ON/OFF Signal and Inner Signal Setting Screen</u>
②	TIME SIGNAL	Set relay number for the time signal output.	▶ See <u>2.10.4 Time Signal Setting Screen</u>
③	ALARM SIGNAL	Set relay number for the alarm signal output.	▶ See <u>2.12.6 Alarm and DI Error Name Setting Screen</u>
④	ON/OFF SIGNAL	Set relay number for the ON/OFF signal output.	▶ See <u>2.12.3 ON/OFF Signal and Inner Signal Setting Screen</u> ▶ Relay is "ON" after setting time. ☞ Setting time is applied one time.
⑤	TEMP RUN SIGNAL	Set relay number for the temperature running signal output.	▶ It occurs that control temperature at Fix running or Program running. ▶ Relay is "ON" after setting time.
⑥	HUMI RUN SIGNAL	Set relay number for the humidity running signal output.	▶ It occurs that control humidity at Fix running or Program running. ▶ Relay is "ON" after setting time.
⑦	TEMP UP SIGNAL	Set relay number for the temperature Up signal output.	▶ FIX RUN → Setting range : EUS 0% ~ EUS 10%
⑨	TEMP DOWN SIGNAL	Set relay number for the temperature Down signal output.	▶ PROG RUN → Relay is "ON" during TSP minus setting temperature. → Setting range is (EUS 0% ~ EUS 10%) ☞ Status lamp of the running screen and relay is operated at the same time.
⑧	TEMP SOAK SIGNAL	Set relay number for the temperature Soak signal output.	▶ When Fix running, status lamp of the running screen is display but relay output isn't occurred. ▶ When Program running, status lamp of the running screen and relay is "ON" during Soak time minus setting time.
⑩	HUMI UP SIGNAL	Set relay number for the humidity Up signal output.	▶ FIX RUN → Setting range : EUS 0% ~ EUS 10%
⑫	HUMI DOWN SIGNAL	Set relay number for the humidity Down signal output.	▶ PROG RUN → Relay is "ON" during TSP minus setting humidity. → Setting range is (EUS 0% ~ EUS 10%) ☞ Status lamp of the running screen and relay is operated at the same time.

⑪	HUMI SOAK SIGNAL	Set relay number for the humidity Soak signal output.	<ul style="list-style-type: none"> ▶ When Fix running, status lamp of the running screen is display but relay output is not occurred. ▶ When Program running, status lamp of the running screen and relay is "ON" during Soak time minus setting time.
⑬	DRAIN SIGNAL	Set relay number for the drain water of the chamber.	<ul style="list-style-type: none"> ▶ POWER ON → PROG STOP (Relay "ON") ▶ PROG RUN → Temp. SP != DRY LIMIT Range (Relay "ON") → Humi. SP is 0.0% (Relay "ON") ▶ RUN → STOP → "HUMI RUN SIGNAL" STOP (Relay "ON")
⑭	DRAIN RANGE LOW	Display DRAIN range low of the ON/OFF operation.	<ul style="list-style-type: none"> ▶ A case DRY LIMIT LOW of <u>2.12.1.3 Input Display Screen</u> is changed, it is changed. ☞ Not edit.
⑮	DRAIN RANGE HIGH	Display DRAIN range high of the ON/OFF operation.	<ul style="list-style-type: none"> ▶ A case DRY LIMIT HIGH of <u>2.12.1.3 Input Display Screen</u> is changed, it is changed. ☞ Not edit.
⑯	ERROR SIGNAL	Set relay number for the error signal output.	<ul style="list-style-type: none"> ▶ when DI error(DI2 ~ DI8) is occurred, Relay status is "ON" while setting time.
⑰	PATTERN END SIGNAL	Set relay number for the pattern end signal output.	<ul style="list-style-type: none"> ▶ when program pattern is ended, Relay status is "ON" while setting time.
⑱	1st REF. SIGNAL	Set relay number for the first REF. signal output.	<ul style="list-style-type: none"> ▶ A case where Inner Signal1(IS1) output is occurred, Relay status is "ON" after setting time(second).
⑲	2nd REF. SIGNAL	Set relay number for the second REF. signal output.	<ul style="list-style-type: none"> ▶ A case where Inner Signal1(IS1) output is occurred, Relay status is "ON" after setting time(minute).

☞ A case where setting relay number is duplicated, an occasion what kind of signal output is occurred, relay is operated.("OR" Condition)



UP, SOAK, DOWN Signal

NOTE

- ▶ INPUT = TEMP(PT_1), RANGE = -50.00℃ ~ 150.00℃
- ▶ UP, DOWN SIGNAL RANGE → [EUS 0% ~ EUS 10%] = [0.00℃ ~ 20.00℃]

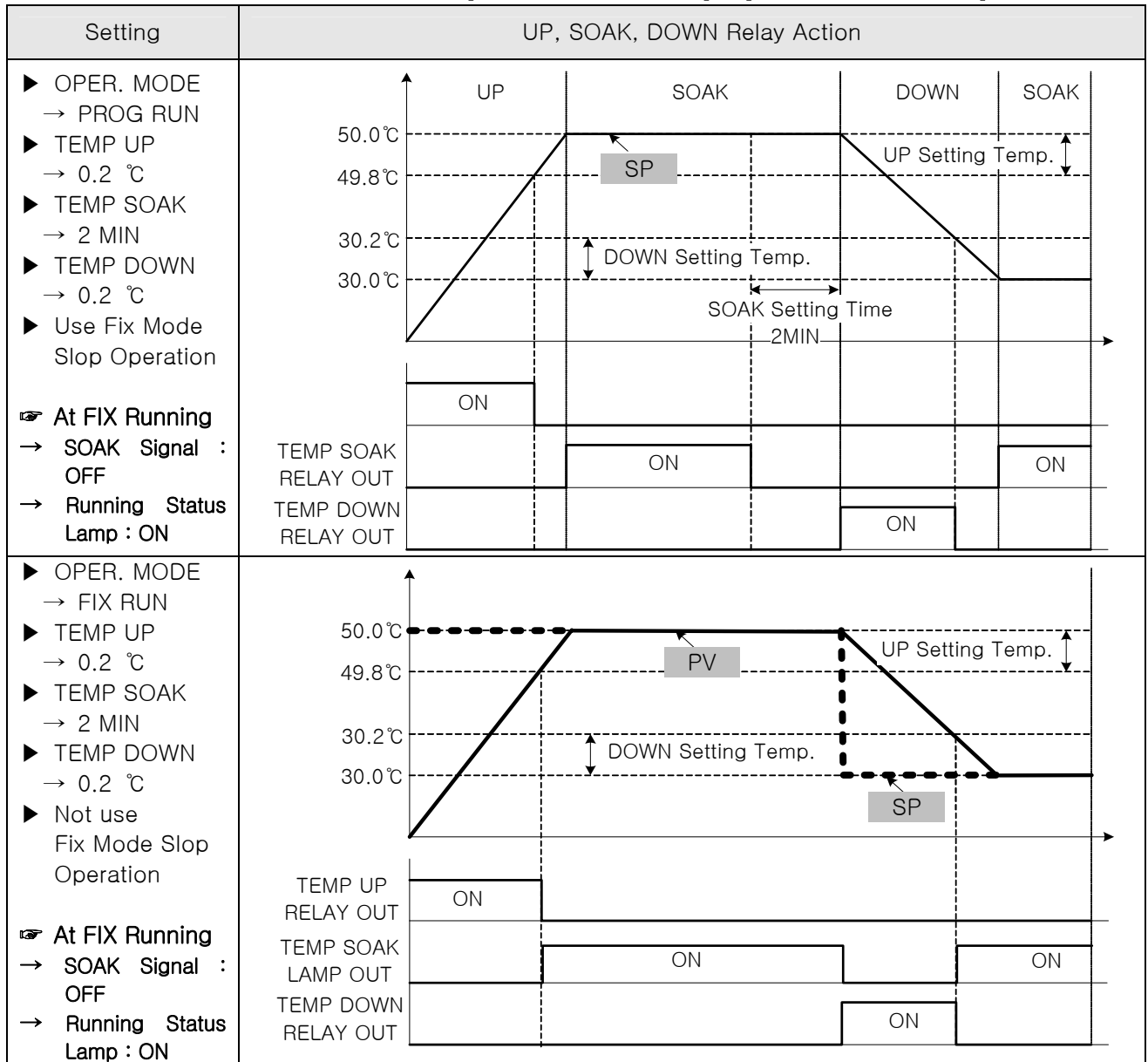

2.12.6 Alarm and DI Error Name Setting Screen

2.12.6.1 Alarm Setting

Figure 2-62. Alarm Setting Screen

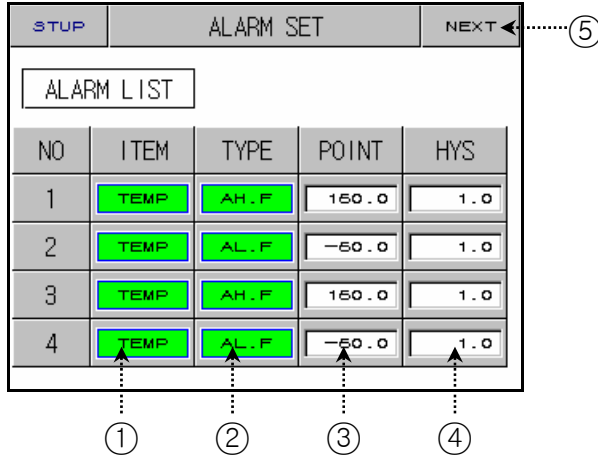

No.	Contents	Description	Additional Description			
①	ITEM SELECT	Select alarm mode.				
②	ALARM TYPE SELECT	Select alarm type.	Display	Alarm Type	Direction	Wait
			AH.F	Absolute-Value Upper-Limit Alarm	Forward	No
			AL.F	Absolute-Value Lower-Limit Alarm	Forward	No
			DH.F	Upper-Limit Alarm of Deviation	Forward	No
			DL.F	Lower-Limit Alarm of Deviation	Forward	No
			DH.R	Upper-Limit Alarm of Deviation	Reverse	No
			DL.R	Lower-Limit Alarm of Deviation	Reverse	No
			DO.F	Upper-and-Lower-Limit Alarm of Deviation	Forward	No
			DI.F	Upper-and-Lower-Limit Range Alarm of Deviation	Forward	No
			AH.R	Absolute-Value Upper Limit Alarm	Reverse	No
			AL.R	Absolute-Value Lower Limit Alarm	Reverse	No
			AH.FS	Absolute-Value Upper-Limit Alarm with Standby	Forward	Yes
			AL.FS	Absolute-Value Lower-Limit Alarm with Standby	Forward	Yes
			DH.FS	Upper-Limit Alarm of Deviation with Standby	Forward	Yes
			DL.FS	Lower-Limit Alarm of Deviation with Standby	Forward	Yes
DH.FS	Upper-Limit Alarm of Deviation with Standby	Reverse	Yes			
DL.RS	Lower-Limit Alarm of Deviation with Standby	Reverse	Yes			
DO.FS	Upper-and-Lower-Limit Alarm of Deviation with Standby	Forward	Yes			

			DI.FS	Upper-and-Lower-Limit Range Alarm of Deviation with Standby	Reverse	Yes
			AH.RS	Absolute-Value Upper-Limit Alarm with Standby	Reverse	Yes
			AL.RS	Absolute-Value Lower-Limit Alarm with Standby	Reverse	Yes
③	ALARM POINT	Set alarm point.				
④	ALARM HYSTERESIS	Set alarm hysteresis.				
⑤	NEXT BUTTON	Move DI error name setting screen.	▶ See 2.12.6.2 DI Error Name Setting Screen			

☞ Alarm action is occurred not only PROG RUN but also PROG STOP.

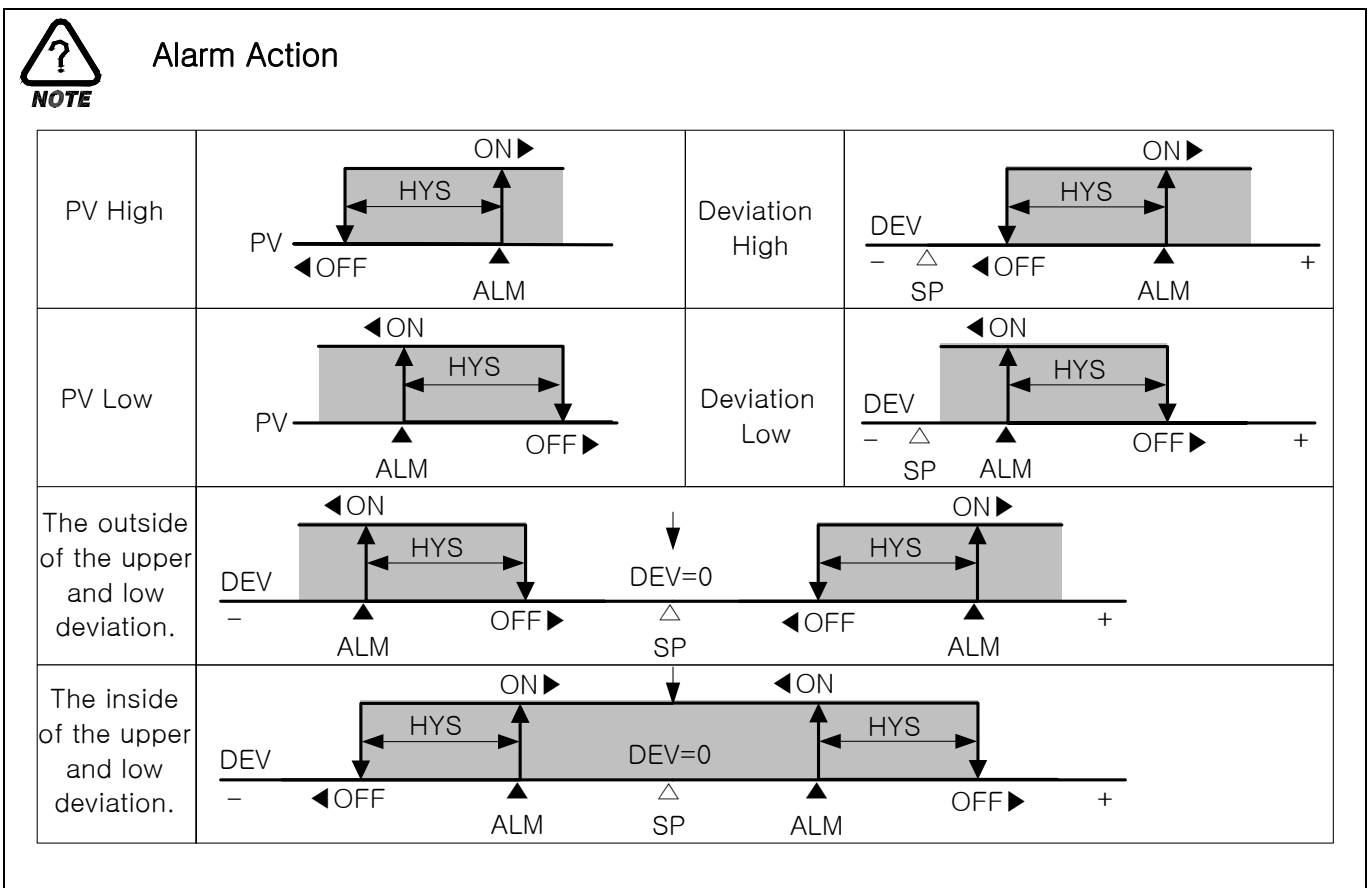

2.12.6.2 DI Error Name Setting

Figure 2-63. DI Error Name Setting Screen

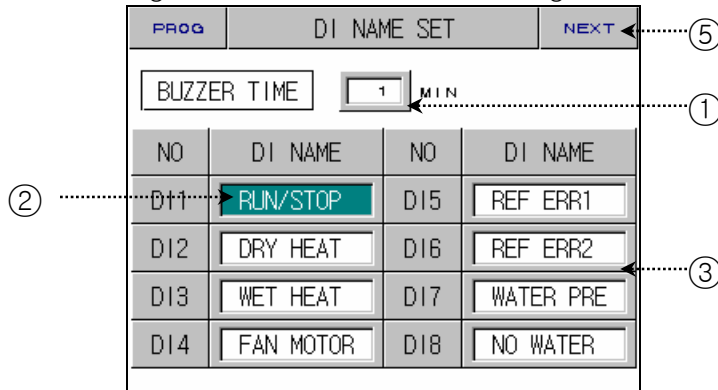

No.	Contents	Description	Additional Description
①	BUZZER TIME	Set buzzer time.	▶ Buzzer occurs 1 minute even if buzzer time set "0".
②	D11	Select running status(Run/Stop) using D11.	☞ Not edit.
③	D12 ~ D18 NAME SET	Set DI error name.	▶ See 2.10.6.1 The Method of the Pattern Name Setting
④	NEXT BUTTON	Move alarm setting screen.	▶ See 2.12.6.1 Alarm Setting Screen

2.12.6.3 DI Error Occurrence Screen

Figure 2-64. DI Error Occurrence Screen

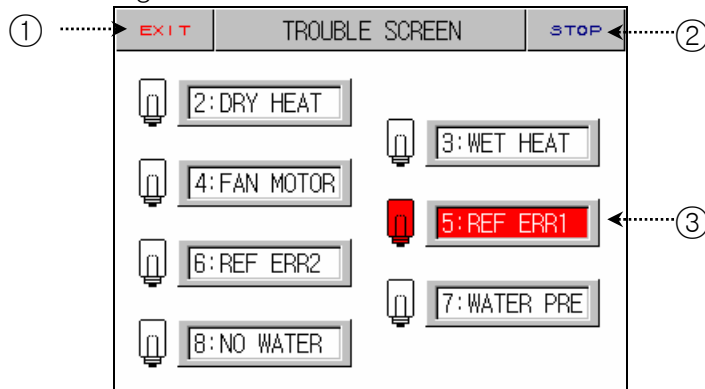

No.	Contents	Description	Additional Description
①	EXIT BUTTON	Exit trouble screen.	▶ Move running screen. ☞ If it remains unsolved problem, it displays DI error occurrence screen repeatedly.
②	STOP BUTTON	Stop buzzer.	
③	DI ERROR ON	Display DI error.	▶ Display red color. ☞ A case where error release, the displayed color is changed to green.

☞ A case where occurs error(DI2~DI8), Operation is stopped.

2.12.7 Communication Setting Screen

► This is the screen about communication setting.

Figure 2-65. Communication Setting Screen

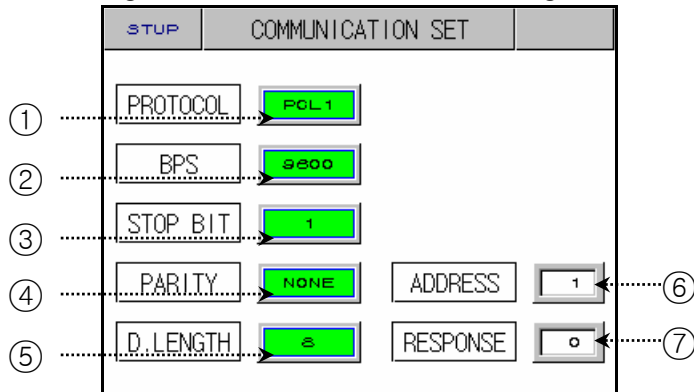

No.	Contents	Description	Additional Description
①	PROTOCOL	Set communication protocol.	► TEMI880 monitoring program uses PC LINK1(Check Sum).
②	BIT PER SEC	Set board rate.	
③	STOP BIT	Set stop bit.	
④	PARITY	Set parity	
⑤	DATA LENGTH	Set data length.	
⑥	ADDRESS	Set address.	► RS232C – 1:1, RS485C – 1:99
⑦	RESPONSE TIME	Set response time	

2.12.8 Initial Display and Status Display Lamp Setting Screen

2.12.8.1 Initial Display Setting

Figure 2-66. Initial Display Setting Screen

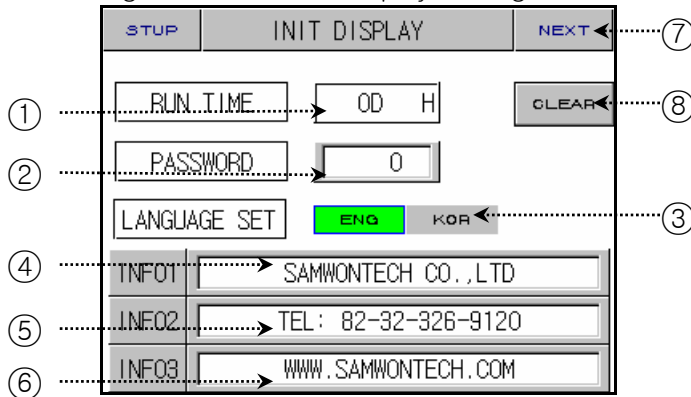

No.	Contents	Description	Additional Description
①	RUN TIME	Total process time.	
②	PASSWORD SET	Change password for the enter 2.12 System Setting Screen .	<ul style="list-style-type: none"> ▶ Initial value is “0”. ▶ In this case forgot password, Call our authorized service center.
③	LANGUAGE SET	Select language.	
④	INFORMATION1	Set company name.	
⑤	INFORMATION2	Set telephone number.	
⑥	INFORMATION3	Set homepage address.	
⑦	NEXT BUTTON	Move status display lamp setting screen.	▶ See 2.12.8.2 Status Display Lamp Setting Screen
⑧	CLEAR BUTTON	Delete total process time.	

2.12.8.2 Status Display Lamp Setting

Figure 2-67. Status Display Lamp Setting Screen

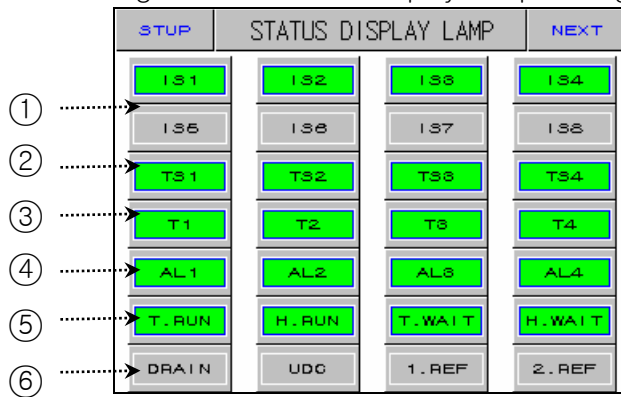

No.	Contents	Description	Additional Description
①	IS1 ~ IS8	Inner signal display lamp.	<ul style="list-style-type: none"> ▶ Total lamp count is twenty. ▶ Selected lamp is changed green color. ▶ Selected lamp is displayed second screen of the PROG or FIX Run.
②	TS1 ~ TS4	Time signal display lamp.	
③	T1 ~ T4	ON/OFF signal display lamp.	
④	AL1 ~ AL4	Alarm signal display lamp.	
⑤	T.RUN	Temp. run signal display lamp.	
	H.RUN	Humi. run signal display lamp.	
	T.WAIT	Temp. wait signal display lamp.	
	H.WAIT	Humi. wait signal display lamp.	
⑥	DRAIN	Signal display lamp for the draining.	
	UDC	Signal display lamp for the UDC machine action.	
	1.REF	Signal display lamp for the first refrigeration machine action.	
	2.REF	Signal display lamp for the second refrigeration machine action.	

2.13 Password Input Screen

► This is the screen about password input.

Figure 2-68. Password Input Screen – SETUP

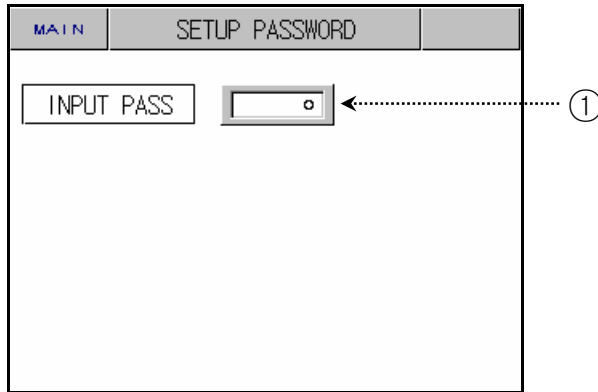
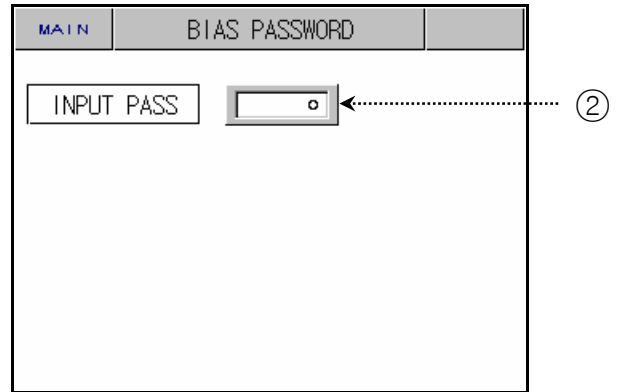

Figure 2-69. Password Input Screen – BIAS



No.	Contents	Description	Additional Description
①	INPUT PASSWORD	Setup password.	<ul style="list-style-type: none"> ► Initial password is “0”. ✎ Users can change password at 2.12.8.1 Initial Display Setting.
②	INPUT PASSWORD	Bias password.	

▪ Simple Example

► The Example of the Pattern, Inner Signal and Time Signal Setting.

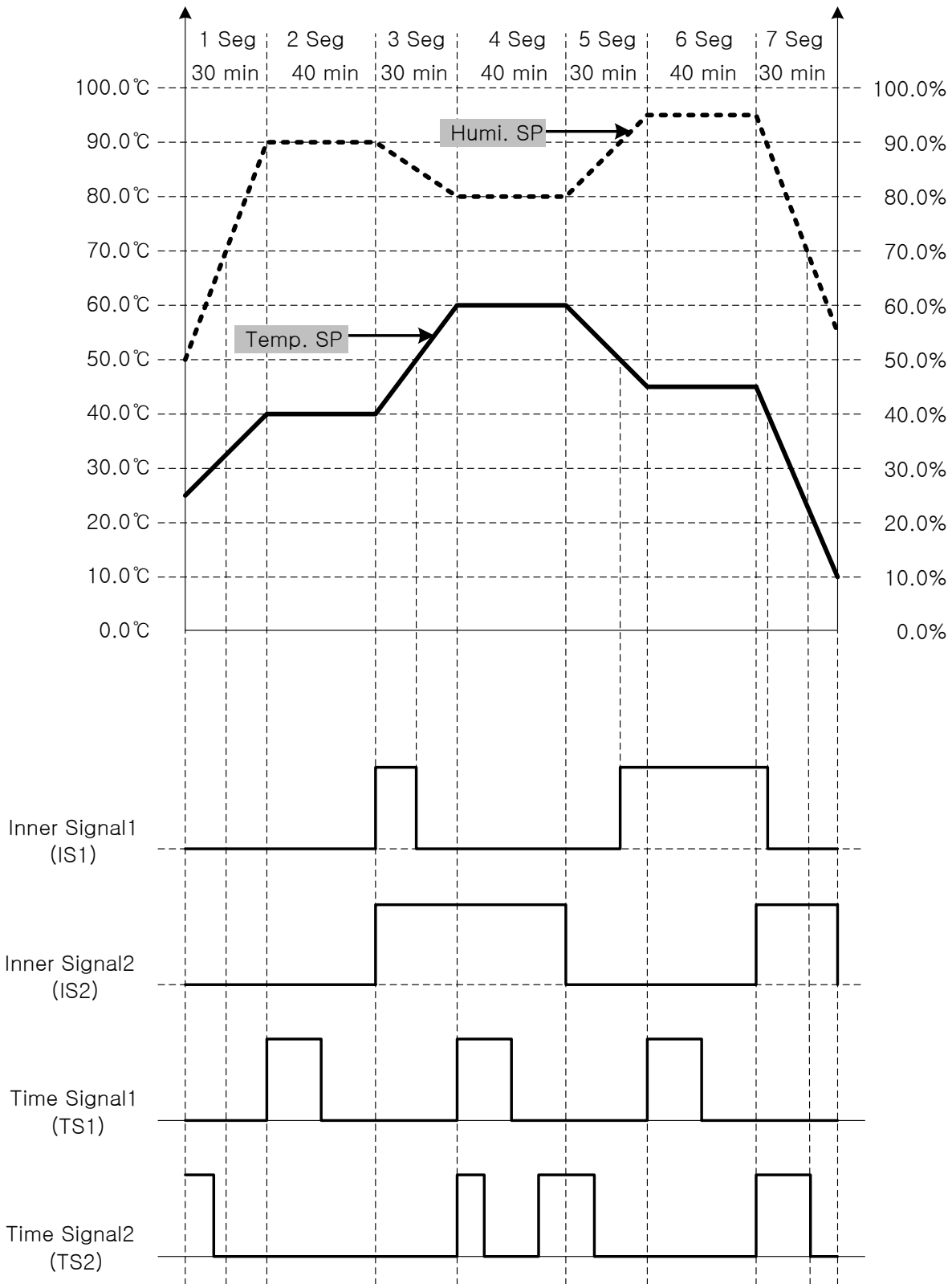

① Set Pattern.

PROG		PATTERN SET							INFO
PATTERN NO		001							
SEG	TEMP	HUMI	TIME	TS ₁	TS ₂	TS ₃	TS ₄		
01	40.00	90.0	0.30	00	00	00	00		
02	40.00	90.0	0.40	00	00	00	00		
03	60.00	80.0	0.30	00	00	00	00		
04	60.00	80.0	0.40	00	00	00	00		
PGUP		PGDN	INSERT	DELETE					

PROG		PATTERN SET							INFO
PATTERN NO		001							
SEG	TEMP	HUMI	TIME	TS ₁	TS ₂	TS ₃	TS ₄		
05	45.00	95.0	0.30	00	00	00	00		
06	45.00	95.0	0.40	00	00	00	00		
07	10.00	55.0	0.30	00	00	00	00		
08	-50.00	0.0	-0.01	00	00	00	00		
PGUP		PGDN	INSERT	DELETE					

② Set Inner Signal.

STUP		INNER SIGNAL SET			NEXT
IS LIST					
NO	RANGE-L	RANGE-H	TIME		▲
IS1	40.0	50.0	00.00		
	TEMP	SP	INB		
IS2	40.0	50.0	00.00		▼
	TEMP	TSP	OUTB		

③ Set Time Signal.

PROG		TIME SIGNAL SET			
TS NO(0~7)					
NO	ON TIME	OFF TIME			▲
00	TS OFF	TS OFF			
01	TS ON	TS ON			
02	00.20 HH.MM	00.20	HH.MM		▼
03	00.10 HH.MM	00.20	HH.MM		

PROG		PATTERN SET							INFO
PATTERN NO		001							
SEG	TEMP	HUMI	TIME	TS ₁	TS ₂	TS ₃	TS ₄		
01	40.00	90.0	0.30	00	03	00	00		
02	40.00	90.0	0.40	02	00	00	00		
03	60.00	80.0	0.30	00	00	00	00		
04	60.00	80.0	0.40	02	03	00	00		
PGUP		PGDN	INSERT	DELETE					

PROG		PATTERN SET							INFO
PATTERN NO		001							
SEG	TEMP	HUMI	TIME	TS ₁	TS ₂	TS ₃	TS ₄		
05	45.00	95.0	0.30	00	03	00	00		
06	45.00	95.0	0.40	02	00	00	00		
07	10.00	55.0	0.30	00	02	00	00		
08	-50.00	0.0	-0.01	00	00	00	00		
PGUP		PGDN	INSERT	DELETE					

3. Parameter Setting Table

► This tables display setting range and initial value of the each parameters.

2.7 Set Operation				
Symbol	Parameter	Setting Range	Unit	Init. Value
OPER. MODE	OPERATION MODE	PROG, FIX	ABS	PROG
POWER MODE	POWER MODE	STOP, COLD, HOT	ABS	STOP
FUZZY SELECT	FUZZY SELECT	OFF, ON	ABS	OFF
KEY LOCK	KEY LOCK	OFF, ON	ABS	OFF
LIGHT OFF	LIGHT OFF	0~99	ABS	OFF
OPER. HOUR	OPERATION HOUR	0~9999	ABS	0
OPER. MIN	OPERATION MINUTE	0~59	ABS	0
TIME MODE	TIME MODE	OFF, ON	ABS	OFF
TEMP SLOPE	TEMP SLOPE	T.EUS(0~100%)/MIN	T.EUS/MIN	T.EUS(0%)/MIN
HUMI SLOPE	HUMI SLOPE	H.EUS(0~100%)/MIN	H.EUS/MIN	H.EUS(0%)/MIN

2.8 Set Reservation				
Symbol	Parameter	Setting Range	Unit	Init. Value
Y	YEAR	0~99	ABS	01
M	MONTH	1~12	ABS	01
D	DAY	1~31	ABS	01
H	HOUR	0~23	ABS	01
M	MINUTE	0~59	ABS	00
RESERVE MODE	RESERVE MODE	OFF, ON	ABS	OFF

2.9 Set Graph and Graph Data Storage				
Symbol	Parameter	Setting Range	Unit	Init. Value
PTNO	PATTERN NUMBER	0~120	ABS	0
TEMP SP	TEMP SP DISPLAY	OFF, ON	ABS	ON
HUMI SP	HUMI SP DISPLAY	OFF, ON	ABS	ON
OPER. MODE	OPERATION MODE	STOP, RUN	ABS	STOP
TIME UNIT	TIME UNIT	SEC, MIN	ABS	SEC
SAMPLING TIME	SAMPLING TIME	1~59	ABS	5
BACK UP	SELECT BACK UP	PTN, PARA, ALL	ABS	PTN
DIRECT	SELECT DIRECT	DNLOAD, UPLOAD	ABS	DNLOAD

2.10.1 Edit Pattern				
Symbol	Parameter	Setting Range	Unit	Init. Value
PATTERN NO	PATTERN NUMBER	1~120	ABS	1
TEMP	SEGMENT TEMP SP	T.EU(0~100%)	T.EU	T.EU(0%)
HUMI	SEGMENT HUMI SP	H.EU(0~100%)	H.EU	H.EU(0%)
TIME	SEGMENT TIME	-0.01(OFF)~99.59 (HOUR.MIN)	ABS	-0.01(OFF)
TS1~TS4	TIME SIGNAL1~4	0~7	ABS	0(OFF)

2.10.2 Set Repeat				
Symbol	Parameter	Setting Range	Unit	Init. Value
PTN NO	PATTERN NUMBER	1~120	ABS	1
PTN RPT	PATTERN REPEAT COUNT	0(Infinite)~999	ABS	1
LINK PTN	LINK PATTERN	0~120	ABS	0
START	START SEGMENT	0~99	ABS	0
END	END SEGMENT	0~99	ABS	0
COUNT	SEGMENT COUNT	0~99	ABS	0

2.10.3 Edit File				
Symbol	Parameter	Setting Range	Unit	Init. Value
SRC. PTNO	SOURCE PATTERN NUMBER	1~120	ABS	0
DES. PTNO	DESTINATION PATTERN NUMBER	1~120	ABS	0
DEL. PTNO	DELETE PATTERN NUMBER	1~120	ABS	0

2.10.4 Set Time Signal				
Symbol	Parameter	Setting Range	Unit	Init. Value
ON TIME	TIME SIGNAL ON TIME	00.00~99.59 (HOUR.MIN)	ABS	00.00
OFF TIME	TIME SIGNAL OFF TIME	00.00~99.59 (HOUR.MIN)	ABS	00.00

2.10.5 Set Wait Operation				
Symbol	Parameter	Setting Range	Unit	Init. Value
WAIT MODE	WAIT MODE	OFF, ON	ABS	OFF
TEMP ZONE	TEMP WAIT ZONE	T.EUS(0~100%)	T.EUS	T.EUS(0%)
HUMI ZONE	HUMI WAIT ZONE	H.EUS(0~100%)	H.EUS	H.EUS(0%)
WAIT TIME	WAIT TIME	00.00~99.59 (HOUR.MIN)	ABS	0(OFF)

2.10.6 Set Pattern Name				
Symbol	Parameter	Setting Range	Unit	Init. Value
PTNO 1~120	PATTERN NAME 1~120	0~9, A~Z, Special character (Max 10 characters)	ABS	PROG PT001 ~ PROG PT120

2.11 Select Screen				
Symbol	Parameter	Setting Range	Unit	Init. Value
TUNING KEY	TUNING KEY DISPLAY BUTTON	HIDE, DISP	ABS	DISP
CONTRAST SET	CONTRAST GROUP SET	DARK, NOR, LIGHT	ABS	NOR

2.12.1.1 Set Temperature Input				
Symbol	Parameter	Setting Range	Unit	Init. Value
SENSOR TYPE	TEMP SENSOR TYPE	PT_1(-90.00~200.00) PT_2(-100.0~300.00) DCV(-1.000~2.000)	ABS	PT_1
TEMP RH	TEMP RANGE HIGH	T.EU(0~100%)	T.EU	T.EU(100%)
TEMP RL	TEMP RANGE LOW	TEMP RL < TEMP RH	T.EU	T.EU(0%)
TEMP BIAS	TEMP BIAS	T.EUS(-105~105%)	T.EUS	T.EUS(0%)
DISPLAY FILTER	DISPLAY FILTER	OFF, 1~120	ABS	OFF
FILTER TIME	TEMP FILTER TIME	0~120 SEC	ABS	0
TEMP SH	TEMP SCALE HIGH	-100.0~200.0	ABS	200.0
TEMP SL	TEMP SCALE LOW	TEMP SL < TEMP SH	ABS	-100.0

2.12.1.2 Set Humidity Input				
Symbol	Parameter	Setting Range	Unit	Init. Value
SENSOR TYPE	HUMI SENSOR TYPE	PT(-10.0~110.0) DCV(1.000~5.000)	ABS	PT
HUMI RH	HUMI RANGE HIGH	H.EU(0~100%)	H.EU	H.EU(100%)
HUMI RL	HUMI RANGE LOW	HUMI RL < HUMI RH	H.EU	H.EU(0%)
HUMI BIAS	HUMI BIAS	H.EUS(-20~20%)	H.EUS	H.EUS(0%)
FILTER TIME	HUMI FILTER TIME	0~120 SEC	ABS	0
HUMI SH	HUMI SCALE HIGH	0.0~100.0	ABS	100.0
HUMI SL	HUMI SCALE LOW	HUMI SL < HUMI SH	ABS	0.0

2.12.1.3 Display Input				
Symbol	Parameter	Setting Range	Unit	Init. Value
WET ADJUST	WET TEMP ADJUST	H.EUS(-105~105%)	H.EUS	H.EUS(0%)
DRY LIMIT RH	DRY TEMP LIMIT HIGH	0.0~100.0	ABS	100.0
DRY LIMIT RL	DRY TEMP LIMIT LOW	DRY LIMIT RL < DRY LIMIT RH	ABS	0.0

2.12.1.4 Set Range Input Correction				
Symbol	Parameter	Setting Range	Unit	Init. Value
POINT1.DDV POINT2.DDV POINT3.DDV POINT4.DDV	DRY TEMP DIFFERENCE VALUE1~4	T.EUS(-10~10%)	T.EUS	T.EUS(0%)
POINT1.DPV	DRY TEMP REFERENCE POINT1	T.EU(0~100%) DRY RL ≤ POINT1.DPV ≤ POINT2.DPV ≤ POINT3.DPV ≤ POINT4.DPV ≤ DRY.RH	T.EU	T.EU(0%)
POINT2.DPV	DRY TEMP REFERENCE POINT2		T.EU	T.EU(100%)
POINT3.DPV	DRY TEMP REFERENCE POINT3		T.EU	T.EU(100%)
POINT4.DPV	DRY TEMP REFERENCE POINT4		T.EU	T.EU(100%)
POINT1.WDV POINT2.WDV POINT3.WDV POINT4.WDV	WET TEMP DIFFERENCE VALUE1~4	H.EUS(-10~10%)	H.EUS	H.EUS(0%)
POINT1.DPV	WET TEMP REFERENCE POINT1	H.EU(0~100%) WET RL ≤ POINT1.WPV ≤ POINT2.WPV ≤ POINT3.WPV ≤ POINT4.WPV ≤ WET.RH	H.EU	H.EU(0%)
POINT2.DPV	WET TEMP REFERENCE POINT2		H.EU	H.EU(100%)
POINT3.DPV	WET TEMP REFERENCE POINT3		H.EU	H.EU(100%)
POINT4.DPV	WET TEMP REFERENCE POINT4		H.EU	H.EU(100%)
POINT1.RDV POINT2.RDV POINT3.RDV POINT4.RDV	HUMIDITY DIFFERENCE VALUE1~4	H.EUS(-10~10%)	H.EUS	H.EUS(0%)
POINT1.DPV	HUMIDITY REFERENCE POINT1	H.EU(0~100%) HUMI.RL ≤ POINT1.RPV ≤ POINT2.RPV ≤ POINT3.RPV ≤ POINT4.RPV ≤ HUMI.RH	H.EU	H.EU(0%)
POINT2.DPV	HUMIDITY REFERENCE POINT2		H.EU	H.EU(100%)
POINT3.DPV	HUMIDITY REFERENCE POINT3		H.EU	H.EU(100%)
POINT4.DPV	HUMIDITY REFERENCE POINT4		H.EU	H.EU(100%)

2.12.2.1 Set Control Output

Symbol	Parameter	Setting Range	Unit	Init. Value
OUTPUT TYPE	TEMP OUTPUT TYPE	SSR, SCR	ABS	SSR
DIRECTION	TEMP OUTPUT DIRECTION	REV, FWD	ABS	REV
CYCLE TIME	TEMP SSR CYCLE TIME	1~300 SEC	ABS	1
TEMP ARW SET	TEMP ANTI RESET WIND-UP	0.0(AUTO), 0.0~200.0	ABS	100.0
TEMP AT-GAIN	TEMP AUTO TUNING GAIN	0.1~10.0	ABS	1.0
OUTPUT TYPE	HUMI OUTPUT TYPE	SSR, SCR	ABS	SSR
DIRECTION	HUMI OUTPUT DIRECTION	REV, FWD	ABS	REV
CYCLE TIME	HUMI SSR CYCLE TIME	1~300 SEC	ABS	1
HUMI ARW SET	HUMI ANTI RESET WIND-UP	0.0(AUTO), 0.0~200.0	ABS	100.0
HUMI AT-GAIN	HUMI AUTO TUNING GAIN	0.1~10.0	ABS	1.0

2.12.2.2 Set Transmission Output

Symbol	Parameter	Setting Range	Unit	Init. Value
TEMP RET.	TEMP RETRANSMISSION	PV, SP, MV	ABS	PV
TEMP RET. RH	TEMP RET. RANGE HIGH	T.EU(0~100%) TEMP RET RL < TEMP RET RH	T.EU	T.EU(100%)
TEMP RET. RL	TEMP RET. RANGE LOW		T.EU	T.EU(0%)
HUMI RET.	HUMI RETRANSMISSION	PV, SP, MV	ABS	PV
HUMI RET. RH	HUMI RET. RANGE HIGH	H.EU(0~100%) HUMI RET RL < HUMI RET RH	H.EU	H.EU(100%)
HUMI RET. RL	HUMI RET. RANGE LOW		H.EU	H.EU(0%)

2.12.3.1 Set ON/OFF Signal

Symbol	Parameter	Setting Range	Unit	Init. Value
LSP	LOW SP	T.EU(0~100%) TEMP RL ≤ LOW SP < MIDDLE SP < HIGH SP ≤ TEMP RH	T.EU	T.EU(0%)
MSP	MIDDLE SP		T.EU	T.EU(0%)
HSP	HIGH SP		T.EU	T.EU(0%)
HD	HIGH DIFFERENCE	T.EUS(0~10%)	T.EUS	T.EUS(0%)
LD	LOW DIFFERENCE	T.EUS(0~10%)	T.EUS	T.EUS(0%)

2.12.3.2 Set Inner Signal

Symbol	Parameter	Setting Range	Unit	Init. Value
RANGE-L	INNER SIGNAL RANGE LOW	T.EU(0~100%) RANGE-L ≤ RANGE-H	T.EU	T.EU(0%)
RANGE-H	INNER SIGNAL RANGE HIGH		T.EU	T.EU(0%)
TIME	INNER SIGNAL DELAY TIME	00.00~99.59 (HOUR.MIN)	ABS	00.00
ITEM	INNER SIGNAL ITEM	TEMP, HUMI	ABS	TEMP
TYPE	INNER SIGNAL TYPE	SP, PV, TSP	ABS	SP
BAND	INNER SIGNAL BAND DIRECT	INB, OUTB	ABS	INB

2.12.4.1 Set PID Range

Symbol	Parameter	Setting Range	Unit	Init. Value
TEMP AT	TEMP AUTO TUNING POINT	0.01~1.00	ABS	0.10
H.COMD	HUMIDITY CONTROL MODE	CMD0, CMD1	ABS	CMD1
HUMI AT	HUMI AUTO TUNING POINT	0.01~1.00	ABS	0.10
T1	TEMP REFERENCE POINT1	DRY.L < T1 < DRY.H	ABS	(D.RL+D.RH)/2
H2	HUMI REFERENCE POINT2	H.EU(0~100%) HUMI RL < H1 < H2 < HUMI RH	H.EU	2(H.RL+H.RH)/3
H1	HUMI REFERENCE POINT1		H.EU	(H.RL+H.RH)/3
T3	TEMP REFERENCE POINT3	T.EU(0~100%) TEMP RL < T2 < T3 < TEMP RH	T.EU	2(T.RL+T.RH)/3
T2	TEMP REFERENCE POINT2		T.EU	(T.RL+T.RH)/3

2.12.4.2 Set PID Group(PID1~PID9)

Symbol	Parameter	Setting Range	Unit	Init. Value
P	PROPORTIONAL BAND	0.1~999.9	ABS	5.0
I	INTEGRAL TIME	0~6000	ABS	120
D	DERIVATIVE TIME	0~6000	ABS	30
OH	OUTPUT LIMIT HIGH	0.0~100.0 OL < OH	ABS	100.0
OL	OUTPUT LIMIT LOW		ABS	0.0

2.12.5 Set DO CONFIG

Symbol	Parameter	Setting Range	Unit	Init. Value
IS1~IS8 RELAY	INNER SIGNAL1~8 RELAY	0(OFF)~20	ABS	0
TS1~TS4 RELAY	TIME SIGNAL1~4 RELAY	0(OFF)~20	ABS	0
AL1~AL4 RELAY	ALARM SIGNAL1~4 RELAY	0(OFF)~20	ABS	0
T1~T4 RELAY	ON/OFF SIGNAL1~4 REALY	0(OFF)~20	ABS	0
T1~T4 C PARA	ON/OFF SIGNAL1~4 DELAY	00.00~99.59 (MIN.SEC)	ABS	00.00
T.RUN RELAY	TEMP RUN RELAY	0(OFF)~20	ABS	0
T.RUN C PARA	TEMP RUN DELAY	0~999 SEC	ABS	0
H.RUN RELAY	HUMI RUN RELAY	0(OFF)~20	ABS	0
H.RUN C PARA	HUMI RUN DELAY	0~999 SEC	ABS	0
T.UP RELAY	TEMP UP RELAY	0(OFF)~20	ABS	0
T.UP C PARA	TEMP UP RANGE	T.EUS(-10~10%)	T.EUS	T.EUS(0%)
T.SK RELAY	TEMP SOAK RELAY	0(OFF)~20	ABS	0
T.SK C PARA	TEMP SOAK TIME	0~999 MIN	ABS	0
T.DN RELAY	TEMP DOWN RELAY	0(OFF)~20	ABS	0
H.DN C PARA	HUMI DOWN RANGE	H.EUS(-10~10%)	H.EUS	H.EUS(0%)
H.UP RELAY	HUMI UP RELAY	0(OFF)~20	ABS	0

H.UP CPARA	HUMI UP RANGE	H.EUS(-10~10%)	H.EUS	H.EUS(0%)
H.SK RELAY	HUMI SOAK RELAY	0(OFF)~20	ABS	0
H.SK CPARA	HUMI SOAK TIME	0~999 MIN	ABS	0
H.DN RELAY	HUMI DOWN RELAY	0(OFF)~20	ABS	0
H.DN CPARA	HUMI DOWN RANGE	H.EUS(-10~10%)	H.EUS	H.EUS(0%)
DRAIN RELAY	DRAIN RELAY	0(OFF)~20	ABS	0
DRAIN CPARA	DRAIN TIME	0~999 MIN	ABS	0
ERROR RELAY	ERROR RELAY	0(OFF)~20	ABS	0
ERROR CPARA	ERROR TIME	0~999 MIN	ABS	0
PTEND RELAY	PATTERN END RELAY	0(OFF)~20	ABS	0
PTEND CPARA	PATTERN END TIME	0~999 SEC	ABS	0
1REF RELAY	FIRST REF. RELAY	0(OFF)~20	ABS	0
1REF CPARA	FIRST REF. TIME	0~999 SEC	ABS	0
2REF RELAY	SECOND REF. RELAY	0(OFF)~20	ABS	0
2REF CPARA	SECOND REF. TIME	0~999 MIN	ABS	0

2.12.6.1 Set Alarm

Symbol	Parameter	Setting Range	Unit	Init. Value
ITEM	ITEM	TEMP, HUMI	ABS	ALARM1,3 → TEMP ALARM2,4 → HUMI
TYPE	ALARM TYPE	AH.F, AL.F, DH.F DL.F, DH.R, DL.R DO.F, DI.F, AH.R AL.R, AH.FS, AL.FS DH.FS, DL.FS, DH.FS DL.RS, DO.FS, DI.FS AH.RS, AL.RS	ABS	ALARM1,2 → AH.F ALARM3,4 → AL.F
POINT	ALARM POINT	T.EU(-105~105%) H.EU(-105~105%)	T.EU H.EU	EU(100%)
HYS	ALARM HYSTERESIS	T.EUS(0~100%) H.EUS(0~100%)	T.EUS H.EUS	EUS(0.5%)

2.12.6.2 Set DI Error Name

Symbol	Parameter	Setting Range	Unit	Init. Value
BUZZER TIME	BUZZER TIME	0~99 MIN	ABS	1
DI2~DI8 NAME	DI2~DI8 NAME	0~9, A~Z, Special character (Max 10 characters)	ABS	DI2: DRY HEAT DI3: WET HEAT DI4: FAN MOTOR DI5: REF ERR1 DI6: REF ERR2 DI7: WATER PRE DI8: NO WATER

2.12.7 Set Communication

Symbol	Parameter	Setting Range	Unit	Init. Value
PROTOCOL	PROTOCOL	PCL0 (PC LINK), PCL1 (PC LINK with SUM CHECK), MODA(MODBUS ASCII), MODR(MODBUS RTU)	ABS	PCL1
BPS	BIT PER SEC	600, 1200, 2400, 4800, 9600	ABS	9600
STOP BIT	STOP BIT	1, 2	ABS	1
PARITY	PARITY	NONE, EVEN, ODD	ABS	NONE
D.LENGTH	DATA LENGTH	7, 8	ABS	8
ADDRESS	ADDRESS	1 ~99	ABS	1
RESPONSE	RESPONSE TIME	0~10	ABS	0

2.12.8 Set Init. Display

Symbol	Parameter	Setting Range	Unit	Init. Value
PASSWORD SET	PASSWORD SET	0~9999	ABS	0
LANGUAGE SET	LANGUAGE SET	ENG, KOR	ABS	ENG
INFORMATION1	COMPANY INFORMATION	0~9, A~Z, Special character (Max 18 characters)	ABS	SAMWONTECH CO.,LTD
INFORMATION2	TELEPHONE INFORMATION	0~9, A~Z, Special character (Max 18 characters)	ABS	TEL: 82-32- 326-9120
INFORMATION3	HOME PAGE INFORMATION	0~9, A~Z, Special character (Max 18 characters)	ABS	WWW.SAMWON TECH.COM

4. Communication Manual

4.1 Communication Specification

▶ TEMI880 is designed to establish a communication between upper-level computer and display via RS232C and RS485 communication interface. (RS232C – 1:1, RS485 – 1:99)

▶ As below, there are some parameters when the TEMI880 communicates.

PARAMETER	VALUE	FUNCTION
PROTOCOL	PCL0	Basic Protocol
	PCL1	Basic Protocol + Check Sum
	MODA	MODBUS ASCII
	MODR	MODBUS RTU
TRANSMISSION RATE(BPS)	9600	9600 bps
	4800	4800 bps
	2400	2400 bps
	1200	1200 bps
	600	600 bps
PARITY	NONE	None Parity
	EVEN	Even Parity
	ODD	Odd Parity
STOP BIT	1	1 bit
	2	2 bits
DATA LENGTH	8	8 bits
	7	7 bits
ADDRESS	1~99	Address
RESPONSE	0~10	Processing Time + Response * 10msec

■ Default parameter

- PROTOCOL : PCL1(Basic Protocol + Check Sum)
- BPS : 9600 bps
- PARITY : NONE
- STOP BIT : 1 (1 bits)
- DATA LENGTH : 8 (8 bits)
- ADDRESS : 1
- RESPONSE : 0 (Processing Time + 10 msec)

4.2 Communication Terminal Arrangement

- ▶ TEMI880 communication terminal arrangement is depends on option(RS232C or RS485).
Detail in as below.

4.2.1 Terminal RS232C and TEMI880 9 Pin connector

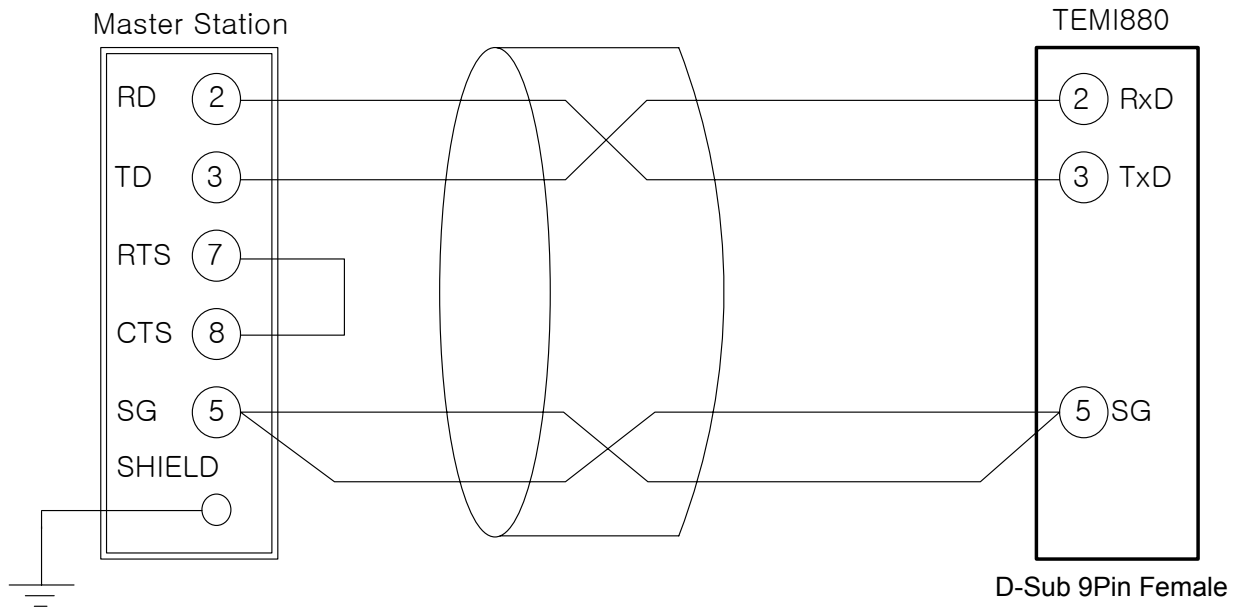

4.2.2 Terminal RS485 and TEMI880's terminal

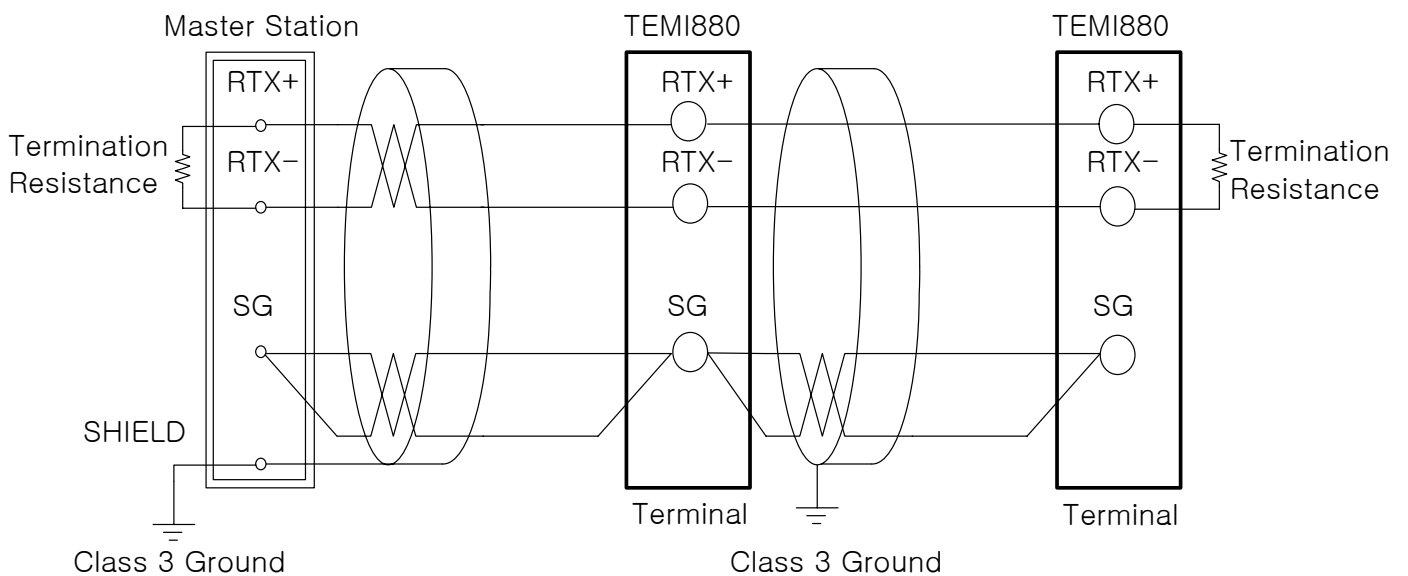

- ☞ TEMI880 is possible MULTIDROP connection.(Max : 99)
- ☞ TEMI880 or MASTER(PC or PLC) needs to use termination resistance(200Ω 1/4W).

4.3 Communication Command

4.3.1 The composition of communication command

► It is basic communication command structure between upper-level computer and TEMI880.

①	②	③	④	⑤	⑥	⑦	⑧
S T X	Address	Command	,	Data by Command rule	SUM	C R	L F

① STX(Start of Text)

This code indicates the start of a command string.

② Address

Communication address to identify the instruments.

③ Command

Specify the command from an upper device (See 4.3.2~4.3.9).

④ ‘,’(Separation character)

Character for separating command and data by ‘,’.

⑤ Data

Data by Command rule.

⑥ Check Sum

It is only using when the protocol is “PCL1”.(basic protocol + check sum)

⑦, ⑧ CR,LF

This control code indicates the end of a command.

4.3.2 Communication Commands

- ▶ There are two kinds of commands, Self-information and Read/Write commands in the TEMI880.

① Self-information command

Command	Process
AMI	Display model name & version.

② Read/Write command

Command	Process
RSD	Reading D-Register orderly.
RRD	Reading D-Register random.
WSD	Writing D-Register의 orderly.
WRD	Writing D-Register의 random.
STD	Random registration of D-Register.
CLD	Call D-Register of STD.

- ☞ Each command can read/write up to 32 D-Register and the all of the STD/CLD data will be reset when the power off, so the data should be registered again.

4.3.3 Error Response

- ▶ The message when the communication error from TEMI880.

Byte	1	2	2	2	2	1	1
Command element	S T X	Address	NG	Number of word(2)	SUM	C R	L F

- ☞ SUM is only using when the PROTOCOL is "PCL1".

4.3.4 RSD Command

► This command for reading D-Register orderly.

► Transmission Format

Byte	1	2	3	1	2	1	4	2	1	1
Command element	S T X	Addr	RSD	,	Para. number	,	D-Reg. No.	SUM	C R	L F

► Response

Byte	1	2	3	1	2	1	4	1	4	1	...
Command element	S T X	Addr	RSD	,	OK	,	dddd-1	,	dddd-2	,	...

1	4	1	4	2	1	1
,	dddd-(n-1)	,	dddd-(n)	SUM	C R	L F

- Para. number : 1~32.
- dddd : Indicates a character string in hexadecimal format.

ex) When reading the D-Register from Temp. PV(D0001) to Temp. SP(D0002).

- Transmission : [stx]01RSD,02,0001[cr][lf]
- Transmission (Include Check Sum) : [stx]01RSD,02,0001C5[cr][lf]
([stx] = 0x02, [cr] = 0x0d, [lf] = 0x0a)

When Temp. PV value is 50.0 and Temp. SP value is 30.0.

- Response : [stx]01RSD,OK,01F4,012C[cr][lf]
- Response (Include Check Sum) : [stx]01RSD,OK,01F4,012C19[cr][lf]

※ Display procedure of the Temp. PV value.

- ① Convert hexadecimal to decimal : 01F4(hexadecimal) → 500(decimal)
- ② converted value * 0.1 : 500 * 0.1 → 50.0

4.3.5 RRD Command

► This command for reading D-Register random.

► Transmission Format

Byte	1	2	3	1	2	1	4	1	4	1	...
Command element	S T X	Addr	RRD	,	Para. number	,	D-Reg. No1	,	D-Reg. No2	,	...

1	4	1	4	2	1	1
,	D-Reg. No(n-1)	,	D-Reg. No(n)	SUM	C R	L F

► Response

Byte	1	2	3	1	2	1	4	1	4	1	...
Command element	S T X	Addr	RRD	,	OK	,	dddd-1	,	dddd-2	,	...

1	4	1	4	2	1	1
,	dddd-(n-1)	,	dddd-n	SUM	C R	L F

- Para. number : 1~32.
- dddd : Indicates a character string in hexadecimal format.

ex) When the reading Temp. SP(D0001), Temp. SP(D0002).

- Transmission : [stx]01RRD,02,0001,0002[cr][lf]
- Transmission (Include Check Sum) : [stx]01RRD,02,0001,0002B2[cr][lf]

When Temp. PV value is 50.0 and Temp. SP value is 30.0.

- Response : [stx]01RRD,OK,01F4,012C[cr][lf]
- Response (Include Check Sum) : [stx]01RRD,OK,01F4,012C18[cr][lf]

4.3.6 WSD Command

► This command for writing D-Register orderly.

► Transmission Format

Byte	1	2	3	1	2	1	4	1	4	1	...
Command element	S T X	Addr	WSD	,	Para. number	,	D-Reg. No1	,	dddd-1	,	...

1	4	1	4	2	1	1
,	dddd-(n-1)	,	dddd-(n)	SUM	C R	L F

► Response

Byte	1	2	3	1	2	2	1	1
Command element	S T X	Addr	WSD	,	OK	SUM	C R	L F

- Para. number : 1~32.
- dddd : Indicates a character string in hexadecimal format.

ex) When the writing Temp. SP(D0102) and Humi. SP(D0103) as the FIX Running.

- Setting Temp. SP : 50.0 °C → Delete decimal point(500) → Hexadecimal(0x01F4)
- Setting Humi. SP : 80.0 % → Delete decimal point(800) → Hexadecimal(0x0320)
- Transmission : [stx]01WSD,02,0102,01F4,0320[cr][lf]
- Transmission(Include Check Sum) : [stx]01WSD,02,0102,01F4,0320C4[cr][lf]

4.3.7 WRD Command

► This command for writing D-Register random.

► Transmission Format

Byte	1	2	3	1	2	1	4	1	4	1	...
Command element	S T X	Addr	WRD	,	Para. number	,	D-Reg. No1	,	dddd-1	,	...

1	4	1	4	2	1	1
,	D-Reg. No(n)	,	dddd-(n)	SUM	C R	L F

► Response

Byte	1	2	3	1	2	2	1	1
Command element	S T X	Addr	WRD	,	OK	SUM	C R	L F

- Para. number : 1~32.
- dddd : Indicates a character string in hexadecimal format.

ex) When the writing Temp. SP(D0102) and Temp. SLOPE(D0106) as the FIX Running.

- Setting Temp. SP : 50.0 °C → Delete decimal point(500) → Hexadecimal(0x01F4)
- Setting Temp. SLOPE : 0.5 °C → Delete decimal point(5) → Hexadecimal(0x0005)
- Transmission : [stx]01WRD,02,0102,01F4,0106,0005[cr][lf]
- Transmission(Include Check Sum) : [stx]01WRD,02,0102,01F4,0106,0005B6[cr][lf]

4.3.8 STD Command

▶ This command is register D-Register which you want to using at the TEMI880.

▶ Transmission Format

Byte	1	2	3	1	2	1	4	1	4	1	...
Command element	S T X	Addr	STD	,	Para. number	,	D-Reg. No1	,	D-Reg. No2	,	...

1	4	1	4	2	1	1
,	D-Reg. No(n-1)	,	D-Reg. No(n)	SUM	C R	L F

▶ Response

Byte	1	2	3	1	2	2	1	1
Command element	S T X	Addr	STD	,	OK	SUM	C R	L F

- Para. number : 1~32.

ex) When the registration Temp. PV(D0001), Temp. SP(D0002), Humi. PV(D0005), Humi. SP(D0006).

- Transmission : [stx]01STD,04,0001,0002,0005,0006[cr][lf]
- Transmission(Include Check Sum) : [stx]01STD,04,0001,0002,0005,00069A[cr][lf]

4.3.9 CLD Command

► This command is reading D-Register, which was registered by STD Command at the TEMI880.

► Transmission Format

Byte	1	2	3	2	1	1
Command element	S T X	Addr	CLD	SUM	C R	L F

► Response

Byte	1	2	3	1	2	1	4	1	4	1	...
Command element	S T X	Addr	CLD	,	OK	,	dddd-1	,	dddd-2	,	...

1	4	1	4	2	1	1
,	dddd-(n-1)	,	dddd-(n)	SUM	C R	L F

- Para. number : 1~32.
- dddd : Indicates a character string in hexadecimal format.

4.4 D-Register Explanation

- D-Register is group of data which can use with communication all of TEMI880's condition. Each group has 100 registers and these are classified as follows.

D-Register Range	Group Name	Description	Read	Write
D0001~D0099	PROCESS	Basic process display	○	X
D0100~D0199	FUNCTION	Operation information display	○	△
D0200~D0299	RESERVATION	Time & Reservation	○	△
D0300~D0399	ON OFF / IS	ON/OFF & Inner signal	○	○
D0400~D0499	ALARM / TS	Alarm & Time signal	○	○
D0500~D0599	TEMP PID	Temp. P.I.D	○	△
D0600~D0699	HUMI PID	Humi. P.I.D	○	△
D0700~D0799	COMM	Communication	○	X
D0800~D0899	OUTPUT	Output	○	△
D0900~D0999	INPUT	Input	○	△
D1000~D1099	PROGRAM	Program	○	○
D1100~D1199	RESERVED	Blank	X	X
D1200~D1299	RESERVED	Blank	X	X
D1300~D1399	FILE1	Display Temp. TSP of segment	○	X
D1400~D1499	FILE2	Display Humi. TSP of segment	○	X
D1500~D1599	FILE3	Display setting time of segment	○	X
D1600~D1699	PROG_INFO	Basic information of program pattern	○	○
D1700~D1799	FILE4	Set TS1 of segment	○	X
D1800~D1899	FILE5	Set TS2 of segment	○	X
D1900~D1999	FILE6	Set TS3 of segment	○	X
D2000~D2099	FILE7	Set TS4 of segment	○	X
D2100~D2399	RESERVED	Blank	X	X

☞ Each D-Register is consisted of hexadecimal 4 characters(2-Byte).

4.4.1 PROCESS

► Process group has basic data. It has Bit Map(Display data by Bit) as follow.

Bit	NOWSTS	OTHERSTS	ISSTS	TSSTS	ALSTS
	(D0010)	(D0011)	(D0012)	(D0013)	(D0014)
0	RESET	T1	IS1	TS1	AL1
1	FIX	T2	IS2	TS2	AL2
2	PROG	T3	IS3	TS3	AL3
3	HOLD	T4	IS4	TS4	AL4
4	WAIT	T.RUN	IS5		
5	TEMP AT	H.RUN	IS6		
6	HUMI AT	T.WAIT	IS7		
7	ERROR	H.WAIT	IS8		
8		DRAIN			
9		1.REF			
10		2.REF			
11					
12					
13					
14					
15					

Bit	SYSERR	DOSTSL	DOSTSH	DIDATA	ERROR
	(D0015)	(D0016)	(D0017)	(D0018)	(D0019)
0		RELAY 1	RELAY 17	DI1	TEMP +OVER
1		RELAY 2	RELAY 18	DI2	TEMP -OVER
2	SYS ERR	RELAY 3	RELAY 19	DI3	
3		RELAY 4	RELAY 20	DI4	
4		RELAY 5		DI5	
5		RELAY 6		DI6	
6		RELAY 7		DI7	
7		RELAY 8		DI8	
8		RELAY 9			HUMI +OVER
9		RELAY 10			HUMI -OVER
10		RELAY 11			
11		RELAY 12			
12		RELAY 13			
13		RELAY 14			
14		RELAY 15			
15		RELAY 16			

☞ It is a D-Register which has usable data except above Bit Map information.

▶ Share running D-Register

D-Reg.	Symbol	Description
D0001	TEMP_NPV	Present Temp. PV
D0002	TEMP_NSP	Present Temp. SP
D0003	WET_NPV	Present wet part Temp. PV
D0004	WET_NSP	Present wet part Temp. SP
D0005	HUMI_NPV	Present Humi. PV
D0006	HUMI_NSP	Present Humi. SP
D0007	TEMP_MVOUT	Output of Temp.
D0008	HUMI_MVOUT	Output of Humi.
D0009	C_PIDNO	Number of running P.I.D

▶ FIX running D-Register

D-Reg.	Symbol	Description
D0020	PROC_TIME_H	FIX running PROCESS TIME (hour)
D0021	PROC_TIME_M	FIX running PROCESS TIME (min)

▶ PROGRAM running D-Register

D-Reg.	Symbol	Description
D0025	RUN_PTNO	Number of running program pattern
D0026	RUN_SEGNO	Number of running segment
D0027	REMAIN_TIME_H	Remaining time(hour) of running segment
D0028	REMAIN_TIME_M	Remaining time(min) of running segment
D0029	WAIT_TIME_H	WAIT TIME(hour) of waiting
D0030	WAIT_TIME_M	WAIT TIME(min) of waiting
D0031	NOW_PT_RPT	Repeat times of present running pattern
D0032	TOTAL_PT_RPT	Repeat times of setting pattern
D0033	NOW_SEG_RPT	Repeat times of present running segment
D0034	TOTAL_SEG_RPT	Repeat times of setting segment
D0035	PREV_TEMP_TSP	Previous segment Temp. TSP(Target Set Point)
D0036	NOW_TEMP_TSP	Present segment Temp. TSP(Target Set Point)
D0037	PREV_HUMI_TSP	Previous segment Humi. TSP(Target Set Point)
D0038	NOW_HUMI_TSP	Present segment Humi. TSP(Target Set Point)
D0039	NOW_SEG_TIME	Setting time of present segment

4.4.2 FUNCTION

► Function group is consisted of D-Registers for operation

► PROGRAM running D-Register

D-Reg.	Symbol	Description
D0100	SET_PTNO	Set pattern number
D0121	WAITMD	Select using WAIT function (0 : OFF 1 : ON)
D0122	TEMP_WATE_ZONE	Set wait zone of Temp.
D0123	HUMI_WATE_ZONE	Set wait zone of Humi.
D0124	WAIT_TIME	Set wait time

► FIX running D-Register

D-Reg.	Symbol	Description
D0102	FIX_TEMP_SP	Set Temp. SP on FIX running
D0103	FIX_HUMI_SP	Set Humi. SP on FIX running
D0110	FIX_OPTM_SELL	Select using FIX OP TIME (0 : OFF 1 : ON)
D0111	FIX_OPTM_H	Set the hour for FIX OP TIME
D0112	FIX_OPTM_M	Set the minute for FIX OP TIME

► Operation D-Register

D-Reg.	Symbol	Status	Value	Description
D0101	STATUS_MODE	RUN	1	PROG/FIX RUN
		HOLD	2	HOLD ON/OFF
		STEP	3	SEGMENT STEP
		STOP	4	PROG/FIX STOP
D0104	OP_MODE	PROG	0	SET PROG MODE
		FIX	1	SET FIX MODE
D0105	PWR_MODE	STOP	0	SET STOP MODE
		COLD	1	SET COLD MODE
		HOT	2	SET HOT MODE

☞ For PROG RUN(or FIX RUN) through communication, TEMI880 must be STOP(PROG STOP/FIX STOP).

Ex) TEMI880 should be PROG STOP(D0104 = 0001, D0101 = 0004) for switching FIX RUN to PROG RUN.

4.4.3 RESERVATION

▶ Reservation group is consisted of confirmation time, setting & reservation time D-Register.

▶ Setting Time D-Register

D-Reg.	기 호	내 용	Read	Write
D0201	NOW_YEAR	TEMI880 Present Time (year)	○	×
D0202	NOW_MONTH	TEMI880 Present Time (month)	○	×
D0203	NOW_DAY	TEMI880 Present Time (day)	○	×
D0204	NOW_HOUR	TEMI880 Present Time (hour)	○	×
D0205	NOW_MIN	TEMI880 Present Time (min)	○	×
D0206	RUN_YEAR	TEMI880 Reservation Time (year)	○	○
D0207	RUN_MONTH	TEMI880 Reservation Time (month)	○	○
D0208	RUN_DAY	TEMI880 Reservation Time (day)	○	○
D0209	RUN_HOUR	TEMI880 Reservation Time (hour)	○	○
D0210	RUN_MIN	TEMI880 Reservation Time (min)	○	○
D0211	SET_YEAR	Setting Time (year)	×	○
D0212	SET_MONTH	Setting Time (month)	×	○
D0213	SET_DAY	Setting Time (day)	×	○
D0214	SET_HOUR	Setting Time (hour)	×	○
D0215	SET_MIN	Setting Time (min)	×	○

▶ Reservation ON/OFF

D-Reg.	Symbol	Status	Value	Description
D200	RESERVE	OFF	0	CANCEL
		ON	1	SET

4.4.4 Set Program Pattern

4.4.4.1 Program

- ▶ Program group is consisted of program pattern setting D-Registers.
- ▶ How to set a program pattern is :
Set one by one with changing number of segment on TEMI880.
- ▶ Program pattern setting D-Register

D-Reg.	Symbol	Value	Description
D1000	P_PTNO	1~120	Set program pattern number to Read or Write
D1001	DEST_PTNO	1~120	Set pattern number to be copied
D1002	P_SEGNO	0	Set to Read or Write on D1603~D1618
		1~99	Set segment to Read or Write
D1003	TRIGGER	1	INIT : D1000~D1004 value set '0'
		2	READ : Reading value of D1000 and D1002
		3	WRITE : Writing value of D1000 and D1002
		4	PT COPY : Copy pattern D1000 to D1001
		5	PT DEL : Delete pattern on D1000
		6	SEG INSERT : Insert segment on D1000 and D1002
		7	SEG DEL : Delete segment on D1000 and D1002
		8	ALL PT : Display pattern of D1000 to D1300 ...
D1004	ANSWER	0	FULL : Full memory for pattern or segment
		1	DONE : Complete D1003(TRIGGER)'s job
		2	PT EMPTY : Empty pattern
		3	SEG EMPTY : Empty segment
		4	PT RUN : PROG RUN Status
		5	PARA ERROR : Setting error on D1000~D1003
		6	PT USED : PROG RUN by pattern
D1010	TEMP_TSP	-	Temp. TSP(Target Set Point) to Read or Write
D1011	HUMI_TSP	-	Humi. TSP(Target Set Point) to Read or Write
D1012	SEG_TIME	-	Segment time to Read or Write
D1013	TS1	-	Time signal 1 to Read or Write
D1014	TS2	-	Time signal 2 to Read or Write
D1015	TS3	-	Time signal 3 to Read or Write
D1016	TS4	-	Time signal 4 to Read or Write

4.4.4.2 Reading program pattern

▶ There is how to read program pattern on TEMI880

- ① Set program pattern number on D1000
- ② Set segment number on D1002
- ③ Set READ TRIGGER('2') on D1003
- ④ Read D1004 data and then wait until DONE('1')
- ⑤ Read Temp. TSP, Humi. TSP and segment time on D1010~1012

☞ This list(①~⑤) is shown that read only one segment which in the program patterns. Therefore, if you want to read several segments you should repeat above step with change the segment number. You can read data on D1603~D1618 when you set zero('0') at D1002 at the step ②.

4.4.4.3 Writing program pattern

▶ There is how to write program pattern on TEMI880

- ① Set program pattern number on D1000
- ② Set segment number on D1002
- ③ Set Temp. TSP, Humi. TSP and segment time on D1010~D1012
- ④ Set WRITE TRIGGER('3') on D1003
- ⑤ Read D1004 data and then wait until DONE('1')

☞ This list(①~⑤) is shown that write only one segment which in the program patterns. Therefore, if you want to write several segments you should repeat above step with change the segment number. You can write data on D1603~D1618 when you set zero('0') at D1002 at the step ②.

4.4.4.4 Pattern copy/delete & Segment insert/delete

▶ Program pattern copy

- ① Set object pattern number on D1000
- ② Set target pattern number on D1001
- ③ Set PT COPY TRIGGER('4') on D1003
- ④ Read D1004 data and then wait until DONE('1')

▶ Program pattern delete

- ① Set delete pattern number on D1000
- ② Set PT DEL TRIGGER('5') on D1003
- ③ Read D1004 data and then wait until DONE('1')

▶ Insert segment

- ① Set program pattern number on D1000
- ② Set insert pattern number on D1002
- ③ Set Temp. TSP, Humi. TSP and segment time on D1010~D1012
- ④ Set SEG INSERT TRIGGER('6') on D1003
- ⑤ Read D1004 data and then wait until DONE('1')

▶ Delete segment

- ① Set program pattern number on D1000
- ② Set delete segment number on D1002
- ③ Set SEG DEL TRIGGER('7') on D1003
- ④ Read D1004 data and then wait until DONE('1')

D-Register 0000~0599

NO	PROCESS	FUNCTION	RESERVATION	ON OFF / IS	ALARM / TS	TEMP_PID
	0	100	200	300	400	500
0		SET_PTNO	RESERVE		AL1_ITEM	TEMP_PB1
1	TEMP_NPV	STATUS_MODE	NOW_YEAR	IS1_ITEM	AL2_ITEM	TEMP_TI1
2	TEMP_NSP	FIX_TEMP_SP	NOW_MONTH	IS1_TYPE	AL3_ITEM	TEMP_TD1
3	WET_NPV	FIX_HUMI_SP	NOW_DAY	IS1_HIGH	AL4_ITEM	TEMP_OH1
4	WET_NSP	OP_MODE	NOW_HOUR	IS1_LOW		TEMP_OL1
5	HUMI_NPV	PWR_MODE	NOW_MIN	IS1_DELAY_TM	AL1_MODE	TEMP_MR1
6	HUMI_NSP	TEMP_SLOPE	RUN_YEAR	IS1_BAND	AL2_MODE	TEMP_PB2
7	TEMP_MVOUT	HUMI_SLOPE	RUN_MONTH	IS2_ITEM	AL3_MODE	TEMP_TI2
8	HUMI_MVOUT	FUZZY	RUN_DAY	IS2_TYPE	AL4_MODE	TEMP_TD2
9	C_PIDNO	ADJUST	RUN_HOUR	IS2_HIGH		TEMP_OH2
10	NOW_STS	FIX_OPTM_SELL	RUN_MIN	IS2_LOW	A1_POINT	TEMP_OL2
11	OTHER_STS	FIX_OPTM_H	SET_YEAR	IS2_DELAY_TM	A2_POINT	TEMP_MR2
12	IS_STS	FIX_OPTM_M	SET_MONTH	IS2_BAND	A3_POINT	TEMP_PB3
13	TS_STS	TEMP_TUNE	SET_DAY	IS3_ITEM	A4_POINT	TEMP_TI3
14	AL_STS	HUMI_TUNE	SET_HOUR	IS3_TYPE		TEMP_TD3
15	SYS_ERR_STS	HUMI_AT	SET_MIN	IS3_HIGH	A1_HYS	TEMP_OH3
16	UO_STSSL	TEMP_AT		IS3_LOW	A2_HYS	TEMP_OL3
17	UO_STSSH	TEMP_RP1		IS3_DELAY_TM	A3_HYS	TEMP_MR3
18	DI_DATA	TEMP_RP2		IS3_BAND	A4_HYS	TEMP_PB4
19	ADERR_STS	TEMP_RP3		IS4_ITEM		TEMP_TI4
20	PROC_TIME_H			IS4_TYPE	TS02_ONTM	TEMP_TD4
21	PROC_TIME_M	WAITMD		IS4_HIGH	TS02_OFFTM	TEMP_OH4
22		TEMP_WAIT_ZONE		IS4_LOW	TS03_ONTM	TEMP_OL4
23		HUMI_WAIT_ZONE		IS4_DELAY_TM	TS03_OFFTM	TEMP_MR4
24		WAIT_TIME		IS4_BAND	TS04_ONTM	TEMP_PB5
25	RUN_PTNO	BLGT_TM		IS5_ITEM	TS04_OFFTM	TEMP_TI5
26	RUN_SEGNO	BUZZER_TM		IS5_TYPE	TS05_ONTM	TEMP_TD5
27	REMAIN_TIME_H	HUMI_RP1		IS5_HIGH	TS05_OFFTM	TEMP_OH5
28	REMAIN_TIME_M	HUMI_RP2		IS5_LOW	TS06_ONTM	TEMP_OL5
29	WAIT_TIME_H			IS5_DELAY_TM	TS06_OFFTM	TEMP_MR5
30	WAIT_TIME_M			IS5_BAND	TS07_ONTM	TEMP_PB6
31	NOW_PT_RPT			IS6_ITEM	TS07_OFFTM	TEMP_TI6
32	TOTAL_PT_RPT			IS6_TYPE		TEMP_TD6
33	NOW_SEG_RPT			IS6_HIGH		TEMP_OH6
34	TOTAL_SEG_RPT			IS6_LOW		TEMP_OL6
35	PREV_TEMP_TSP			IS6_DELAY_TM		TEMP_MR6

NO	PROCESS	FUNCTION	RESERVATION	ON OFF / IS	ALARM / TS	TEMP_PID
	0	100	200	300	400	500
36	NOW_TEMP_TSP			IS6_BAND		TEMP_PB7
37	PREV_HUMI_TSP			IS7_ITEM		TEMP_TI7
38	NOW_HUMI_TSP			IS7_TYPE		TEMP_TD7
39	NOW_SEG_TIME			IS7_HIGH		TEMP_OH7
40				IS7_LOW		TEMP_OL7
41				IS7_DELAY_TM		TEMP_MR7
42				IS7_BAND		TEMP_PB8
43				IS8_ITEM		TEMP_TI8
44				IS8_TYPE		TEMP_TD8
45				IS8_HIGH		TEMP_OH8
46				IS8_LOW		TEMP_OL8
47				IS8_DELAY_TM		TEMP_MR8
48				IS8_BAND		TEMP_PB9
49						TEMP_TI9
50				T1_LSV		TEMP_TD9
51				T2_LSV		TEMP_OH9
52				T3_LSV		TEMP_OL9
53				T4_LSV		TEMP_MR9
54						
55				T1_MSV		
56				T2_MSV		
57				T3_MSV		
58				T4_MSV		
59						
60				T1_HSV		
61				T2_HSV		
62				T3_HSV		
63				T4_HSV		
64						
65				T1_HD		
66				T2_HD		
67				T3_HD		
68				T4_HD		
69						
70				T1_LD		
71				T2_LD		

NO	PROCESS	FUNCTION	RESERVATION	ON OFF / IS	ALARM / TS	TEMP_PID
	0	100	200	300	400	500
72				T3_LD		
73				T4_LD		
74						
75						
76						
77						
78						
79						
80						
81						
82						
83						
84						
85						
86						
87						
88						
89						
90						
91						
92						
93						
94						
95						
96						
97						
98						
99						

D-Register 0600~1199

NO	HUMI_PID	COMM	OUTPUT	INPUT	PROGRAM	RESERVED
	600	700	800	900	1000	1100
0	HUMI_PB1	PROTOCOL	TEMP_OT	TEMP_IN	P_PTNO	
1	HUMI_TI1	BAUD_RATE	TEMP_DR	TEMP_RH	DEST_PTNO	
2	HUMI_TD1	PARITY	TEMP_CT	TEMP_RL	P_SEGNO	
3	HUMI_OH1	STOP_BIT	TEMP_ARW	TEMP_BIAS	TRIGGER	
4	HUMI_OL1	DATA_LENGTH		TEMP_FILTER	ANSWER	
5	HUMI_MR1	ADDRESS		TEMP_SH	PTN_NAME1	
6	HUMI_PB2	RESPONSE	TEMP_ATGAIN	TEMP_SL	PTN_NAME2	
7	HUMI_TI2		HUMI_ATGAIN		PTN_NAME3	
8	HUMI_TD2			HUMI_IN	PTN_NAME4	
9	HUMI_OH2			HUMI_RH		
10	HUMI_OL2		HUMI_OT	HUMI_RL	TEMP_TSP	
11	HUMI_MR2		HUMI_DR	HUMI_BIAS	HUMI_TSP	
12	HUMI_PB3		HUMI_CT	HUMI_FILTER	SEG_TIME	
13	HUMI_TI3		HUMI_ARW	HUMI_SH	TS1	
14	HUMI_TD3			HUMI_SL	TS2	
15	HUMI_OH3		TEMP_RETSL	DHLMT	TS3	
16	HUMI_OL3		TEMP_RETH	DLLMT	TS4	
17	HUMI_MR3		TEMP_RETL			
18	HUMI_PB4		HUMI_RETSL			
19	HUMI_TI4		HUMI_RETH			
20	HUMI_TD4		HUMI_RETL			
21	HUMI_OH4			D.TEMP		
22	HUMI_OL4			W.TEMP		
23	HUMI_MR4			HUMIDITY		
24	HUMI_PB5			W.ADJ		
25	HUMI_TI5					
26	HUMI_TD5					
27	HUMI_OH5					
28	HUMI_OL5					
29	HUMI_MR5					
30	HUMI_PB6					
31	HUMI_TI6					
32	HUMI_TD6					
33	HUMI_OH6					
34	HUMI_OL6					
35	HUMI_MR6					

NO	HUMI_PID	COMM	OUTPUT	INPUT	PROGRAM	RESERVED
	600	700	800	900	1000	1100
36						
37						
38						
39						
40			DO_IS1			
41			DO_IS2			
42			DO_IS3			
43			DO_IS4			
44			DO_IS5			
45			DO_IS6			
46			DO_IS7			
47			DO_IS8			
48						
49						
50			DO_TS1			
51			DO_TS2			
52			DO_TS3			
53			DO_TS4			
54						
55			DO_AL1			
56			DO_AL2			
57			DO_AL3			
58			DO_AL4			
59						
60			DO_T1			
61			DO_T1PARA			
62			DO_T2			
63			DO_T2PARA			
64			DO_T3			
65			DO_T3PARA			
66			DO_T4			
67			DO_T4PARA			
68			DO_RUNPARA			
69			DO_HRUNPARA			
70			DO_RUN			
71			DO_HRUN			

NO	HUMI_PID	COMM	OUTPUT	INPUT	PROGRAM	RESERVED
	600	700	800	900	1000	1100
72			DO_TUP			
73			DO_TUPPARA			
74			DO_TSK			
75			DO_TSKPARA			
76			DO_TDN			
77			DO_TDNPARA			
78			DO_HUP			
79			DO_HUPPARA			
80			DO_HSK			
81			DO_HSKPARA			
82			DO_HDN			
83			DO_HDNPARA			
84			DO_DRAIN			
85			DO_DRAINPARA			
86			DO_DRAINRNL			
87			DO_DRAINRNGH			
88			DO_ERROR			
89			DO_ERRORPARA			
90			DO_PTEND			
91			DO_PTENDPARA			
92			DO_1REF			
93			DO_1REFPARA			
94			DO_2REF			
95			DO_2REFPARA			
96						
97						
98						
99						

D-Register 1200~1799

NO	RESERVED	FILE1	FILE2	FILE3	PROG_INFO	FILE4
	1200	1300	1400	1500	1600	1700
0						
1		C_TSP1	C_HSP1	C_TM1		C_TS11
2		C_TSP2	C_HSP2	C_TM2		C_TS12
3		C_TSP3	C_HSP3	C_TM3	PT_REPEAT	C_TS13
4		C_TSP4	C_HSP4	C_TM4	RPT_SEG_S1	C_TS14
5		C_TSP5	C_HSP5	C_TM5	RPT_SEG_E1	C_TS15
6		C_TSP6	C_HSP6	C_TM6	RPT_SEG_C1	C_TS16
7		C_TSP7	C_HSP7	C_TM7	RPT_SEG_S2	C_TS17
8		C_TSP8	C_HSP8	C_TM8	RPT_SEG_E2	C_TS18
9		C_TSP9	C_HSP9	C_TM9	RPT_SEG_C2	C_TS19
10		C_TSP10	C_HSP10	C_TM10	RPT_SEG_S3	C_TS110
11		C_TSP11	C_HSP11	C_TM11	RPT_SEG_E3	C_TS111
12		C_TSP12	C_HSP12	C_TM12	RPT_SEG_C3	C_TS112
13		C_TSP13	C_HSP13	C_TM13	RPT_SEG_S4	C_TS113
14		C_TSP14	C_HSP14	C_TM14	RPT_SEG_E4	C_TS114
15		C_TSP15	C_HSP15	C_TM15	RPT_SEG_C4	C_TS115
16		C_TSP16	C_HSP16	C_TM16		C_TS116
17		C_TSP17	C_HSP17	C_TM17		C_TS117
18		C_TSP18	C_HSP18	C_TM18	LINK_PT	C_TS118
19		C_TSP19	C_HSP19	C_TM19		C_TS119
20		C_TSP20	C_HSP20	C_TM20		C_TS120
21		C_TSP21	C_HSP21	C_TM21		C_TS121
22		C_TSP22	C_HSP22	C_TM22		C_TS122
23		C_TSP23	C_HSP23	C_TM23		C_TS123
24		C_TSP24	C_HSP24	C_TM24		C_TS124
25		C_TSP25	C_HSP25	C_TM25		C_TS125
26		C_TSP26	C_HSP26	C_TM26		C_TS126
27		C_TSP27	C_HSP27	C_TM27		C_TS127
28		C_TSP28	C_HSP28	C_TM28		C_TS128
29		C_TSP29	C_HSP29	C_TM29		C_TS129
30		C_TSP30	C_HSP30	C_TM30		C_TS130
31		C_TSP31	C_HSP31	C_TM31		C_TS131
32		C_TSP32	C_HSP32	C_TM32		C_TS132
33		C_TSP33	C_HSP33	C_TM33		C_TS133
34		C_TSP34	C_HSP34	C_TM34		C_TS134
35		C_TSP35	C_HSP35	C_TM35		C_TS135

NO	RESERVED	FILE1	FILE2	FILE3	PROG_INFO	FILE4
	1200	1300	1400	1500	1600	1700
36		C_TSP36	C_HSP36	C_TM36		C_TS136
37		C_TSP37	C_HSP37	C_TM37		C_TS137
38		C_TSP38	C_HSP38	C_TM38		C_TS138
39		C_TSP339	C_HSP39	C_TM39		C_TS139
40		C_TSP40	C_HSP40	C_TM40		C_TS140
41		C_TSP41	C_HSP41	C_TM41		C_TS141
42		C_TSP42	C_HSP42	C_TM42		C_TS142
43		C_TSP43	C_HSP43	C_TM43		C_TS143
44		C_TSP44	C_HSP44	C_TM44		C_TS144
45		C_TSP45	C_HSP45	C_TM45		C_TS145
46		C_TSP46	C_HSP46	C_TM46		C_TS146
47		C_TSP47	C_HSP47	C_TM47		C_TS147
48		C_TSP48	C_HSP48	C_TM48		C_TS148
49		C_TSP49	C_HSP49	C_TM49		C_TS149
50		C_TSP50	C_HSP50	C_TM50		C_TS150
51		C_TSP51	C_HSP51	C_TM51		C_TS151
52		C_TSP52	C_HSP52	C_TM52		C_TS152
53		C_TSP53	C_HSP53	C_TM53		C_TS153
54		C_TSP54	C_HSP54	C_TM54		C_TS154
55		C_TSP55	C_HSP55	C_TM55		C_TS155
56		C_TSP56	C_HSP56	C_TM56		C_TS156
57		C_TSP57	C_HSP57	C_TM57		C_TS157
58		C_TSP58	C_HSP58	C_TM58		C_TS158
59		C_TSP59	C_HSP59	C_TM59		C_TS159
60		C_TSP60	C_HSP60	C_TM60		C_TS160
61		C_TSP61	C_HSP61	C_TM61		C_TS161
62		C_TSP62	C_HSP62	C_TM62		C_TS162
63		C_TSP63	C_HSP63	C_TM63		C_TS163
64		C_TSP64	C_HSP64	C_TM64		C_TS164
65		C_TSP65	C_HSP65	C_TM65		C_TS165
66		C_TSP66	C_HSP66	C_TM66		C_TS166
67		C_TSP67	C_HSP67	C_TM67		C_TS167
68		C_TSP68	C_HSP68	C_TM68		C_TS168
69		C_TSP69	C_HSP69	C_TM69		C_TS169
70		C_TSP70	C_HSP70	C_TM70		C_TS170
71		C_TSP71	C_HSP71	C_TM71		C_TS171

NO	RESERVED	FILE1	FILE2	FILE3	PROG_INFO	FILE4
	1200	1300	1400	1500	1600	1700
72		C_TSP72	C_HSP72	C_TM72		C_TS172
73		C_TSP73	C_HSP73	C_TM73		C_TS173
74		C_TSP74	C_HSP74	C_TM74		C_TS174
75		C_TSP75	C_HSP75	C_TM75		C_TS175
76		C_TSP76	C_HSP76	C_TM76		C_TS176
77		C_TSP77	C_HSP77	C_TM77		C_TS177
78		C_TSP78	C_HSP78	C_TM78		C_TS178
79		C_TSP79	C_HSP79	C_TM79		C_TS179
80		C_TSP80	C_HSP80	C_TM80		C_TS180
81		C_TSP81	C_HSP81	C_TM81		C_TS181
82		C_TSP82	C_HSP82	C_TM82		C_TS182
83		C_TSP83	C_HSP83	C_TM83		C_TS183
84		C_TSP84	C_HSP84	C_TM84		C_TS184
85		C_TSP85	C_HSP85	C_TM85		C_TS185
86		C_TSP86	C_HSP86	C_TM86		C_TS186
87		C_TSP87	C_HSP87	C_TM87		C_TS187
88		C_TSP88	C_HSP88	C_TM88		C_TS188
89		C_TSP89	C_HSP89	C_TM89		C_TS189
90		C_TSP90	C_HSP90	C_TM90		C_TS190
91		C_TSP91	C_HSP91	C_TM91		C_TS191
92		C_TSP92	C_HSP92	C_TM92		C_TS192
93		C_TSP93	C_HSP93	C_TM93		C_TS193
94		C_TSP94	C_HSP94	C_TM94		C_TS194
95		C_TSP95	C_HSP95	C_TM95		C_TS195
96		C_TSP96	C_HSP96	C_TM96		C_TS196
97		C_TSP97	C_HSP97	C_TM97		C_TS197
98		C_TSP98	C_HSP98	C_TM98		C_TS198
99		C_TSP99	C_HSP99	C_TM99		C_TS199

D-Register 1800~2399

NO	FILE5	FILE6	FILE7	RESERVED	RESERVED	RESERVED
	1800	1900	2000	2100	2200	2300
0						
1	C_TS21	C_TS31	C_TS41			
2	C_TS22	C_TS32	C_TS42			
3	C_TS23	C_TS33	C_TS43			
4	C_TS24	C_TS34	C_TS44			
5	C_TS25	C_TS35	C_TS45			
6	C_TS26	C_TS36	C_TS46			
7	C_TS27	C_TS37	C_TS47			
8	C_TS28	C_TS38	C_TS48			
9	C_TS29	C_TS39	C_TS49			
10	C_TS210	C_TS310	C_TS410			
11	C_TS211	C_TS311	C_TS411			
12	C_TS212	C_TS312	C_TS412			
13	C_TS213	C_TS313	C_TS413			
14	C_TS214	C_TS314	C_TS414			
15	C_TS215	C_TS315	C_TS415			
16	C_TS216	C_TS316	C_TS416			
17	C_TS217	C_TS317	C_TS417			
18	C_TS218	C_TS318	C_TS418			
19	C_TS219	C_TS319	C_TS419			
20	C_TS220	C_TS320	C_TS420			
21	C_TS221	C_TS321	C_TS421			
22	C_TS222	C_TS322	C_TS422			
23	C_TS223	C_TS323	C_TS423			
24	C_TS224	C_TS324	C_TS424			
25	C_TS225	C_TS325	C_TS425			
26	C_TS226	C_TS326	C_TS426			
27	C_TS227	C_TS327	C_TS427			
28	C_TS228	C_TS328	C_TS428			
29	C_TS229	C_TS329	C_TS429			
30	C_TS230	C_TS330	C_TS430			
31	C_TS231	C_TS331	C_TS431			
32	C_TS232	C_TS332	C_TS432			
33	C_TS233	C_TS333	C_TS433			
34	C_TS234	C_TS334	C_TS434			
35	C_TS235	C_TS335	C_TS435			

NO	FILE5	FILE6	FILE7	RESERVED	RESERVED	RESERVED
	1800	1900	2000	2100	2200	2300
36	C_TS236	C_TS336	C_TS436			
37	C_TS237	C_TS337	C_TS437			
38	C_TS238	C_TS338	C_TS438			
39	C_TS239	C_TS339	C_TS439			
40	C_TS240	C_TS340	C_TS440			
41	C_TS241	C_TS341	C_TS441			
42	C_TS242	C_TS342	C_TS442			
43	C_TS243	C_TS343	C_TS443			
44	C_TS244	C_TS344	C_TS444			
45	C_TS245	C_TS345	C_TS445			
46	C_TS246	C_TS346	C_TS446			
47	C_TS247	C_TS347	C_TS447			
48	C_TS248	C_TS348	C_TS448			
49	C_TS249	C_TS349	C_TS449			
50	C_TS250	C_TS350	C_TS450			
51	C_TS251	C_TS351	C_TS451			
52	C_TS252	C_TS352	C_TS452			
53	C_TS253	C_TS353	C_TS453			
54	C_TS254	C_TS354	C_TS454			
55	C_TS255	C_TS355	C_TS455			
56	C_TS256	C_TS356	C_TS456			
57	C_TS257	C_TS357	C_TS457			
58	C_TS258	C_TS358	C_TS458			
59	C_TS259	C_TS359	C_TS459			
60	C_TS260	C_TS360	C_TS460			
61	C_TS261	C_TS361	C_TS461			
62	C_TS262	C_TS362	C_TS462			
63	C_TS263	C_TS363	C_TS463			
64	C_TS264	C_TS364	C_TS464			
65	C_TS265	C_TS365	C_TS465			
66	C_TS266	C_TS366	C_TS466			
67	C_TS267	C_TS367	C_TS467			
68	C_TS268	C_TS368	C_TS468			
69	C_TS269	C_TS369	C_TS469			
70	C_TS270	C_TS370	C_TS470			
71	C_TS271	C_TS371	C_TS471			

NO	FILE5	FILE6	FILE7	RESERVED	RESERVED	RESERVED
	1800	1900	2000	2100	2200	2300
72	C_TS272	C_TS372	C_TS472			
73	C_TS273	C_TS373	C_TS473			
74	C_TS274	C_TS374	C_TS474			
75	C_TS275	C_TS375	C_TS475			
76	C_TS276	C_TS376	C_TS476			
77	C_TS277	C_TS377	C_TS477			
78	C_TS278	C_TS378	C_TS478			
79	C_TS279	C_TS379	C_TS479			
80	C_TS280	C_TS380	C_TS480			
81	C_TS281	C_TS381	C_TS481			
82	C_TS282	C_TS382	C_TS482			
83	C_TS283	C_TS383	C_TS483			
84	C_TS284	C_TS384	C_TS484			
85	C_TS285	C_TS385	C_TS485			
86	C_TS286	C_TS386	C_TS486			
87	C_TS287	C_TS387	C_TS487			
88	C_TS288	C_TS388	C_TS488			
89	C_TS289	C_TS389	C_TS489			
90	C_TS290	C_TS390	C_TS490			
91	C_TS291	C_TS391	C_TS491			
92	C_TS292	C_TS392	C_TS492			
93	C_TS293	C_TS393	C_TS493			
94	C_TS294	C_TS394	C_TS494			
95	C_TS295	C_TS395	C_TS495			
96	C_TS296	C_TS396	C_TS496			
97	C_TS297	C_TS397	C_TS497			
98	C_TS298	C_TS398	C_TS498			
99	C_TS299	C_TS399	C_TS499			



SAMWONTECH CO.,LTD.

202-703, Buchon Techno-park,
Yakdae-dong, Wonmi-gu, Buchon,
Gyeonggi-do, Korea 420-773

TEL : +82-32-326-9120,9121

FAX : +82-32-326-9119

<http://www.samwontech.com>

E-mail:webmaster@samwontech.com

Further information contact Samwontech